

# ida

“yaşam taşıır”

lift  
asansör



ida<sup>oör</sup> lift  
asansör



ida lift  
asansör  
MFL



Overmac

“несет жизнь”

“carries life”

تحمل الحياة

ida | للمصاعد  
lift | лифт  
asansör





*Firma profili*  
*Company profile*

Профиль Компании

نبذة عن المصنع

ift  
asansör  
ida

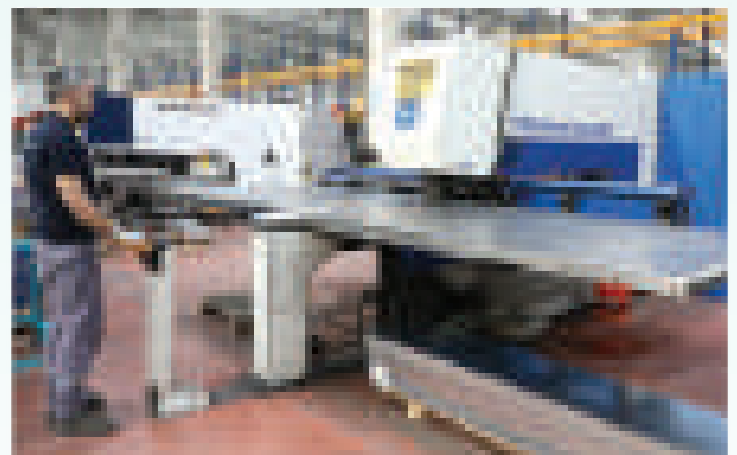
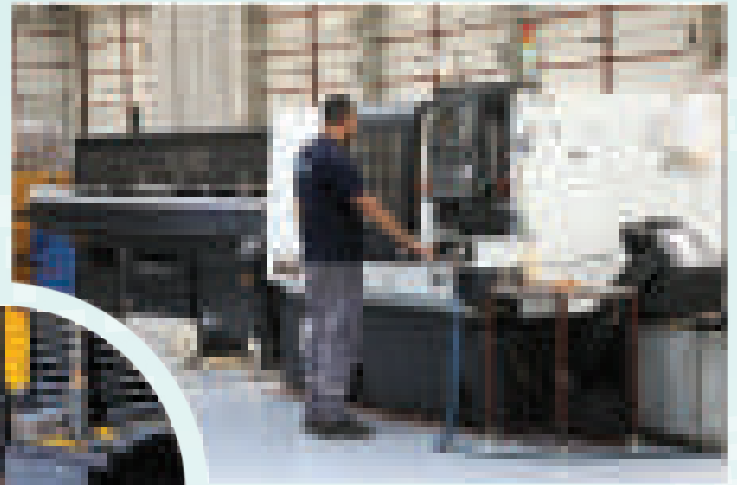

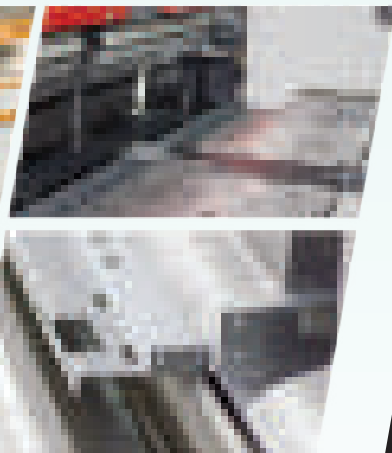
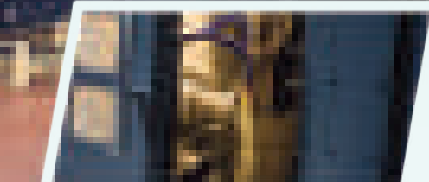
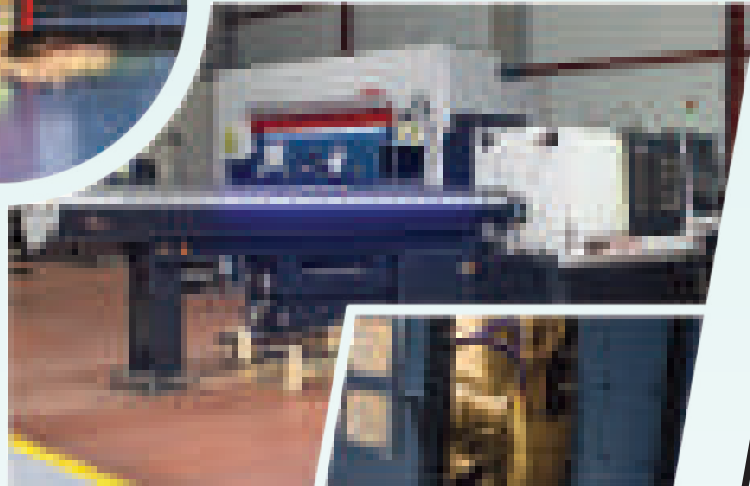
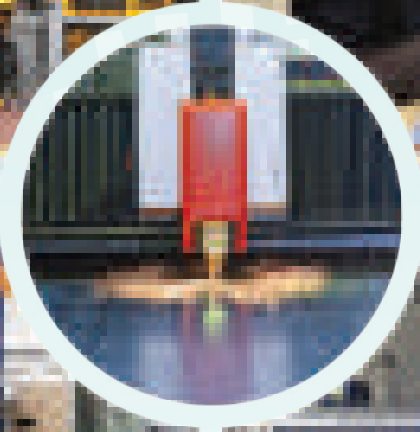
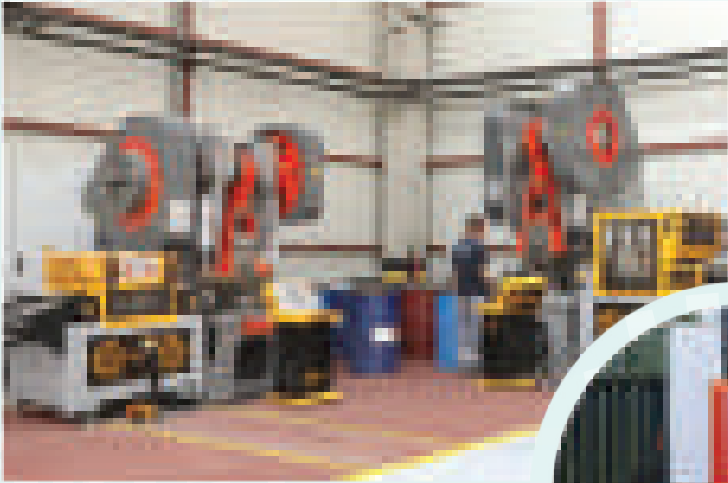

# Firma profili

## Company profile

## Профиль Компании

## نبذة عن المصنع

TR

İda Asansör, 2009 yılında asansör kapı ve kabini üretimi ve satış faaliyetlerini yürütmek üzere kurulmuştur.

İlerleyen yıllarda ürün gamını arttıran ve hem insan hem de makine yatırımı yapan İda Asansör; kabin, tam otomatik kapı, kabin ve ağırlık karkası, makine dairesi ve dairesiz komple paket asansör üretimi ve satışına başlamıştır.

Fabrikamız 13.500 m<sup>2</sup>'si kapalı olmak üzere toplam 20.000 m<sup>2</sup> alana sahiptir. Makine parkurumuz son teknoloji lazer, punch, plasma makineler ve tam otomatik elektrostatik boyama hattı ile donatılmıştır.

Şirketimizin merkez üretim yeri; Malatya 1. Organize Sanayi Sitesi'nde bulunmaktadır.

İda marka ürünlerimiz; sizin beğeniniz sayesinde kısa sürede sektörde önde gelen markalar içinde yer almayı başarmıştır.

İda; müşteri memnuniyeti, kalite, güven, yenilik ve estetik demektir. Hedefimiz sizleri bu ortak noktada buluşturmaktır.

ISO9001:2015 sertifikamız, CE belgemiz, TSE belgelerimiz ve EN 81-58 E120 ile E145 yangına dayanıklı kapı belgelerimiz ürünlerimizin kalite standartlarına uygunluğunun yanı sıra yaptığımız üretime bakış açımızın da açık bir göstergesidir.

EN

IDA Lift was established in 2009 for producing and selling elevator cabins and doors.

Since then, IDA Lift has been investing on human resources and technology (machinery) thus started the production and sales of cabins, fully automated doors, cabin and counterweight frames, complete lifts with or without machine room.

Our plant has an area of total 20.000 m<sup>2</sup> of which 13.500 m<sup>2</sup> is covered. Our machine park has been equipped with the laser, punch, plasma machines and full automatic electrostatic painting line.

Our company's central production plant is located in the 1st Organized Industrial Zone of Malatya.

IDA brand and our products, thanks to our customers appreciation, become one of the leading brands and preferred products in the industry in a short time.

As IDA, our values are; customer satisfaction, quality, reliability, innovation and aesthetic. Our main goal is to deliver these values to our customers as a common point.

Our ISO-9001:2005, CE, TSE (Turkish Standards Institute) certificates and EN 81-58, E120 and E145 fire-resistant door certificates confirm the quality of our products as well as our point of view for production.

# ida

лифт للمصاعد  
lift  
asansör

“carries life” | “yaşam taşıyır”

“несет жизнь” | تحمّل الحياة

RU

Компания İda Лифт, была основана в 2009 году для производства и продажи дверей и кабин лифтов.

В последующие годы Компания İda Лифт, которая расширила ассортимент своей продукции инвестировала как в человеческие ресурсы, так и в машины; начало производства и продажи - кабины, полностью автоматической двери, кабины и грузового каркаса, лифта для помещений с машинным отделением или без него.

Наша фабрика имеет общую площадь 20 000 м<sup>2</sup>, из которых 13 500 м<sup>2</sup> закрыты. Наш машинный парк оборудован по последнему слову техники лазерными, пробивными, плазменными станками и полностью автоматической линией электростатической окраски.

Центр производства расположен в Malatya 1. Organize Sanayi Sitesi.

Наша продукция марки İda; Благодаря вашей оценке, удалось за короткое время занять место среди ведущих брендов отрасли.

İda; означает удовлетворенность клиентов, качество, доверие, инновации и эстетику. Наша цель - объединить вас в этой общей точке.

Сертификаты ISO9001:2015, CE, TSE, а также наши сертификаты на огнестойкие двери – EN 81-58 E30, E160, E190 это помимо соответствия нашей продукции стандартам качества, также наш взгляд на то, чем мы занимаемся.

AR

في العام 2009 تم تأسيس شركة إيدا للمصاعد الآلية لإنتاج ومبيعات أبواب وكابائن المصاعد الآلية.

في السنوات التالية زادت إيدا للمصاعد الآلية من مجموعة منتجاتها واستثمرت في كل من الإنسان والآلة، فبدأت بإنتاج الكبائن، والأبواب الآلية بالكامل، والإطارات الحاملة للكابائن وللأحمال المكافئة، كما بدأت بإنتاج وتجارة حُرْم مصاعد متكاملة سواء مع أبواب غرفة محرك.

تتكون المساحة المغلقة لمصنعنا من 13 ألف متر مربع، والمساحة المكشوفة من 7 آلاف متر مربع، فيكون المجموع الكامل لمساحة المصنع عبارة عن 20 ألف متر مربع، ويحتوي خط الإنتاج على آخر ما توصلت إليه التكنولوجيا الحديثة من آلات الليزر والتقنب والبلازما والثني والقص وخط الطلاء الإلكترونيستاتيكي الآلي بالكامل.

يقع المركز التصنيعي لشركتنا في المنطقة الصناعية الأولى بمدينة مالاطيا التركية.

بفضل تقدير عملائنا فإن علامتنا التجارية إيدا قد نجحت في أن تصبح بين العلامات التجارية الرائدة في وقت قصير.

رضى العملاء، الجودة، الثقة، الأمان، الابتكار، والشكل الجمالي، كانت هي دوماً وستظل هي نقطة التقائنا مع عملائنا.

إن شهادتنا ISO9001، CE، TSE، وشهادات تصنيع الأبواب المقاومة للحرائق EN 81-58 E60، E145 & E120، لهي مقياس عن مواعمة منتجاتنا لمواصفات الجودة، إلى جانب أنها تظهر وجهة نظرنا الواضحة تجاه عملية الإنتاج.



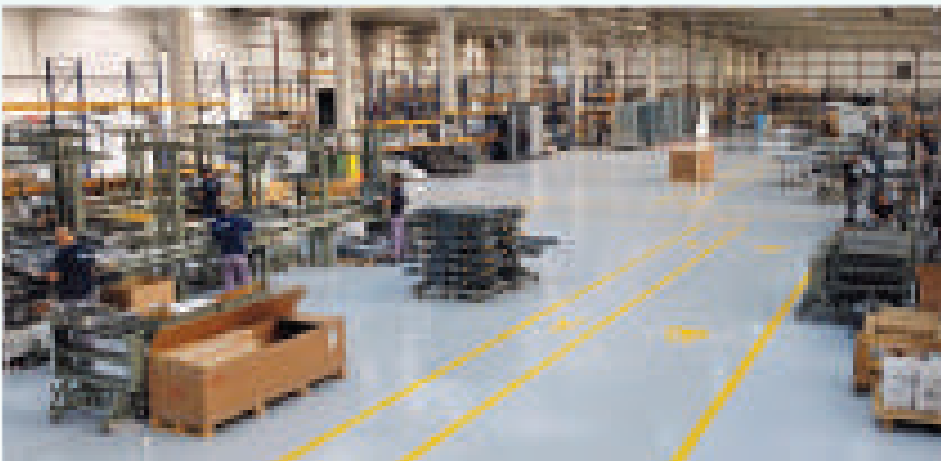
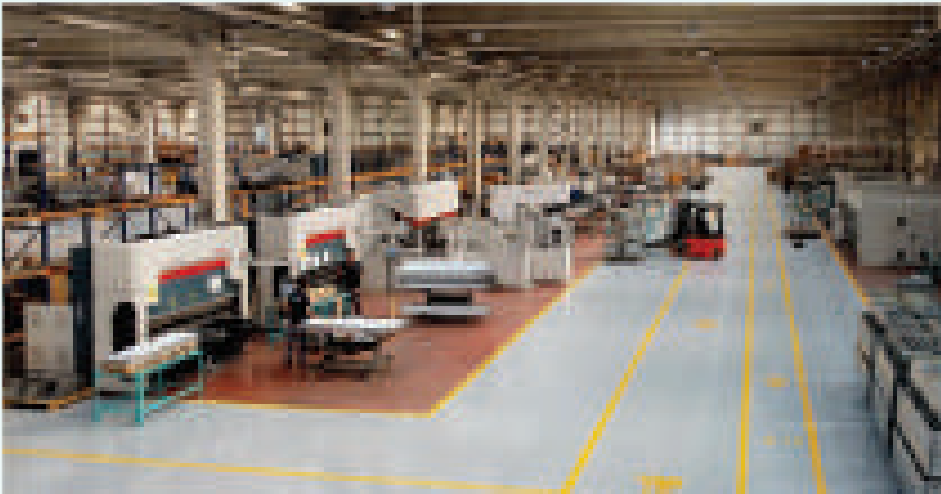
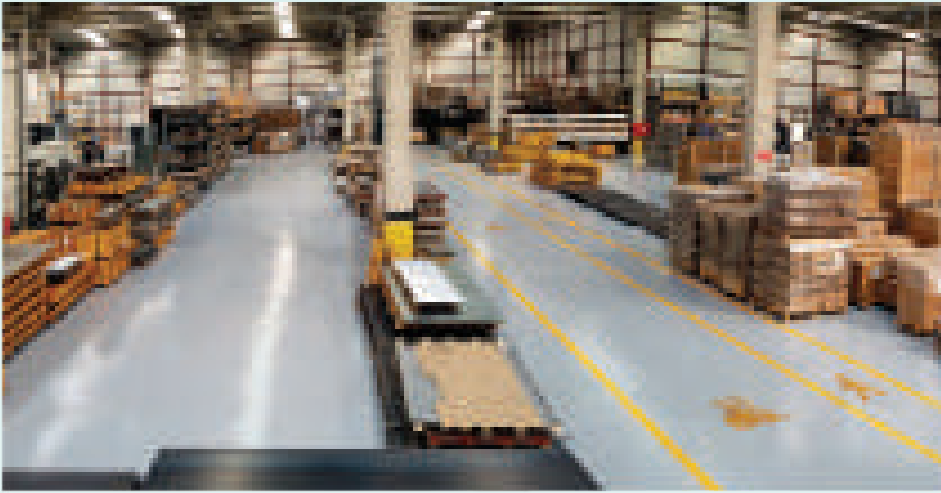



İçindekiler  
Contents  
Содержание  
المحتويات

Sayfa / Page / Страница / الصفحة

Kabinler  
Cabins  
Кабины  
الكبائن

09-38



KBN01



KBN02



KBN03



KBN04

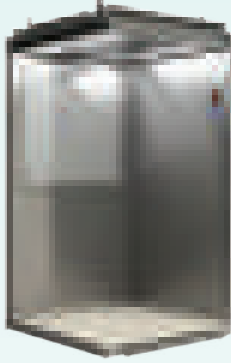

KBN10

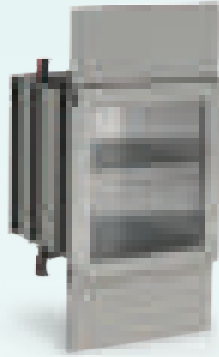

KBN11

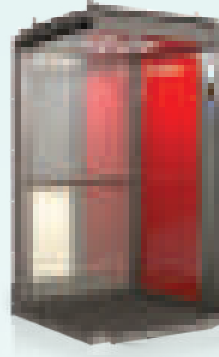

KBN12



KBN13



KBN14



KBN20

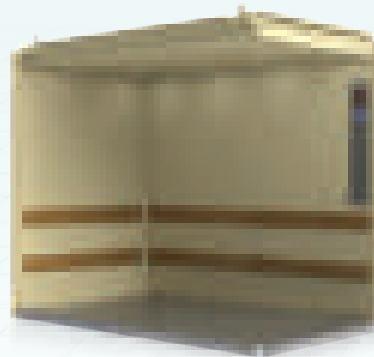

KBN21

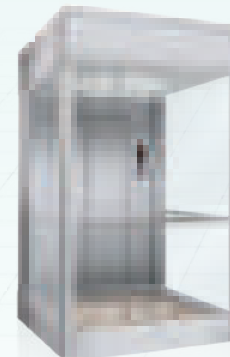

KBN22



KBN23

ida  
lift  
asansör



**KBN05**

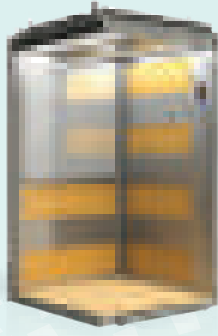

**KBN06**

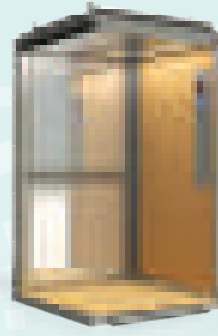

**KBN07**

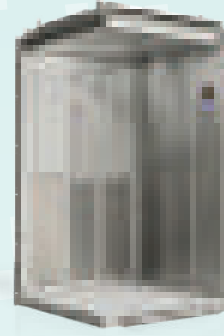

**KBN08**



**KBN09**

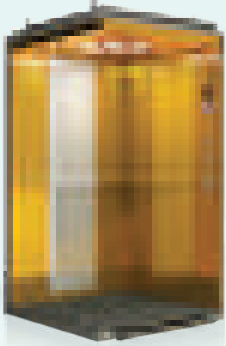

**KBN15**

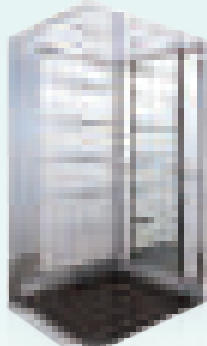

**KBN16**

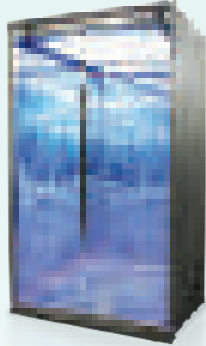

**KBN17**

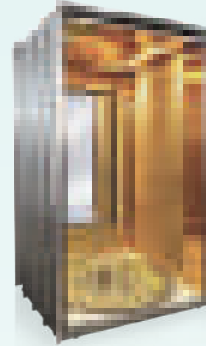

**KBN18**

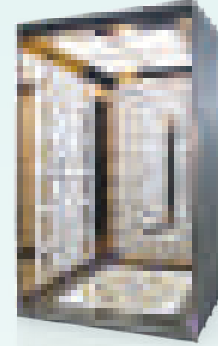

**KBN19**



**KBN24**



**KBN25**

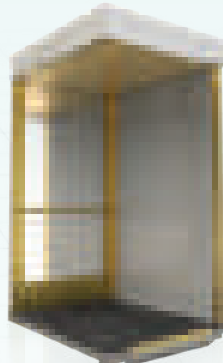

**KBN26**

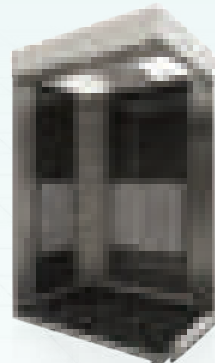

**KBN27**

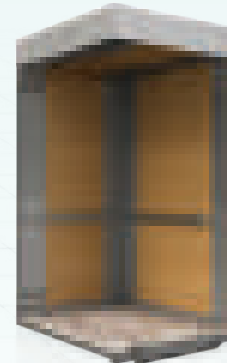

**KBN28**





Kapılar  
Doors 39 - 51 Двери  
الابواب



Komple Asansör Sistemleri  
Complete Elevator Systems 52 - 55 Вся система Лифтов  
انظمة المصاعد المتكاملة



Kumanda Panoları  
Controllers 56 - 57 Панели управления  
لوحات التحكم



Kabin ve Kat Butonyerleri  
Cabin and Landing Panels 58 - 59 Панели управления Кабин и Этажей  
مفاتيح التشغيل الداخلية والخارجية



Asansör Motorları  
Lift Motors 60 - 67 Двигатели Лифта  
محركات المصاعد

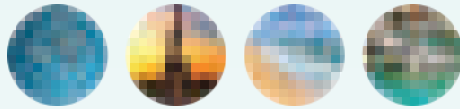

KBN Görsel Seçenekleri  
KBN 15 Images Options 68 - 69 Выбор Изображий для Кабин  
خيارات الصور الداخلية للكابئن



Zemin ve Tavan Seçenekleri  
Floor and Ceiling Options 70 - 71 Выбор Полков и Потолков  
خيارات سقف وأرضيات الكابئن



Paslanmaz ve Laminat Seçenekleri  
Stainless and Laminate Options 72 - 73 Варианты из Нержавеющей  
Стали и Ламината  
خيارات الزخرفة



Sertifikalarımız  
Our Certificates 74 Сертификаты  
الشهادات





idc

**Kabinler** Cabins **Кабины**  
الكبائن



ida

للمصاعد  
lift  
asansör  
лифт

*“carries life”*

*“yaşam taşır”*

*“несет жизнь”*

تحمل الحياة





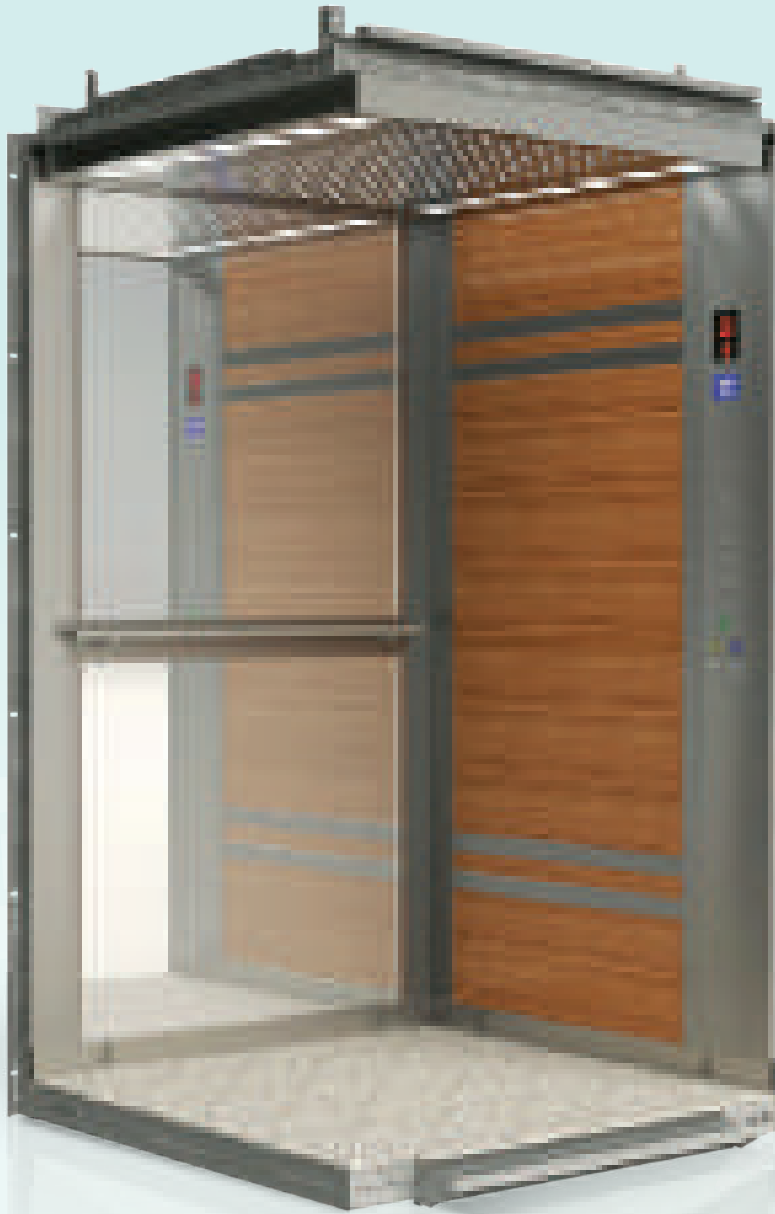

KBN 01

### KBN 01

|             |                                 |
|-------------|---------------------------------|
| Kaplama     | MDF Laminant                    |
| Aksesuar    | Ayna Paslanmaz                  |
| Tavan       | Lazer Kesim                     |
| Zemin       | PVC                             |
| Ayna        | Tam Boy Ayna (Geniş)            |
| Küpeşte     | Arka Duvarda Tekli              |
| Covering    | MDF Laminate                    |
| Accessories | Mirror Stainless Steel          |
| Ceiling     | Laser Cut                       |
| Floor       | PVC                             |
| Mirror      | Full Height Mirror (Wide)       |
| Handrail    | Single The Rear Wall            |
| Покрытие    | Ламинат MDF                     |
| Аksesуары   | Зеркальная Нержавеющая Сталь    |
| Потолок     | Лазерная резка                  |
| Пол         | PVC                             |
| Зеркало     | Зеркало в Полный Рост (Широкое) |
| Поручень    | На задней стене Одинарный       |

|                     |                         |
|---------------------|-------------------------|
| التغطية             | ألواح MDF مصقولة        |
| اكسسوارات           | ستانلس ستيل عاكس        |
| السقف               | مقطوع بالليزر           |
| الارضية             | PVC                     |
| المرآة              | عريضة على كامل الارتفاع |
| مسكات ابواب المصاعد | مفردة على الحائط الخلفي |

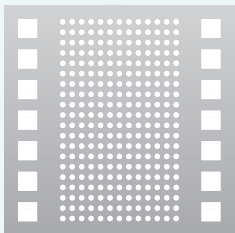

## KBN02

### KBN 02

|             |                               |
|-------------|-------------------------------|
| Kaplama     | MDF Laminant                  |
| Aksesuar    | Ayna Paslanmaz                |
| Tavan       | Lazer Kesim                   |
| Zemin       | PVC                           |
| Ayna        | Tam Boy Ayna (Dar)            |
| Küpeşte     | Arka Duvarda Tekli            |
| Covering    | MDF Laminate                  |
| Accessories | Mirror Stainless Steel        |
| Ceiling     | Laser Cut                     |
| Floor       | PVC                           |
| Mirror      | Full Height Mirror (Narrow)   |
| Handrail    | Single The Rear Wall          |
| Покрытие    | Ламинат MDF                   |
| Аксессуары  | Зеркальная Нержавеющая Сталь  |
| Потолок     | Лазерная резка                |
| Пол         | PVC                           |
| Зеркало     | Зеркало в Полный Рост (Узкое) |
| Поручень    | На задней стене Одинарный     |
| التغطية     | ألواح MDF مصقولة              |
| الاكسسوار   | ستانلس ستيل عاكس              |
| السقف       | مقطوع بالليزر                 |
| الارضية     | PVC                           |
| المرآة      | نحيفة بارتفاع كامل            |
| الدرابزين   | مفردة على الحائط الخلفي       |

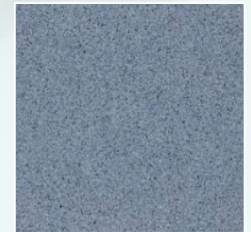
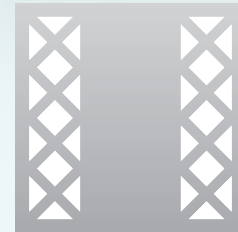

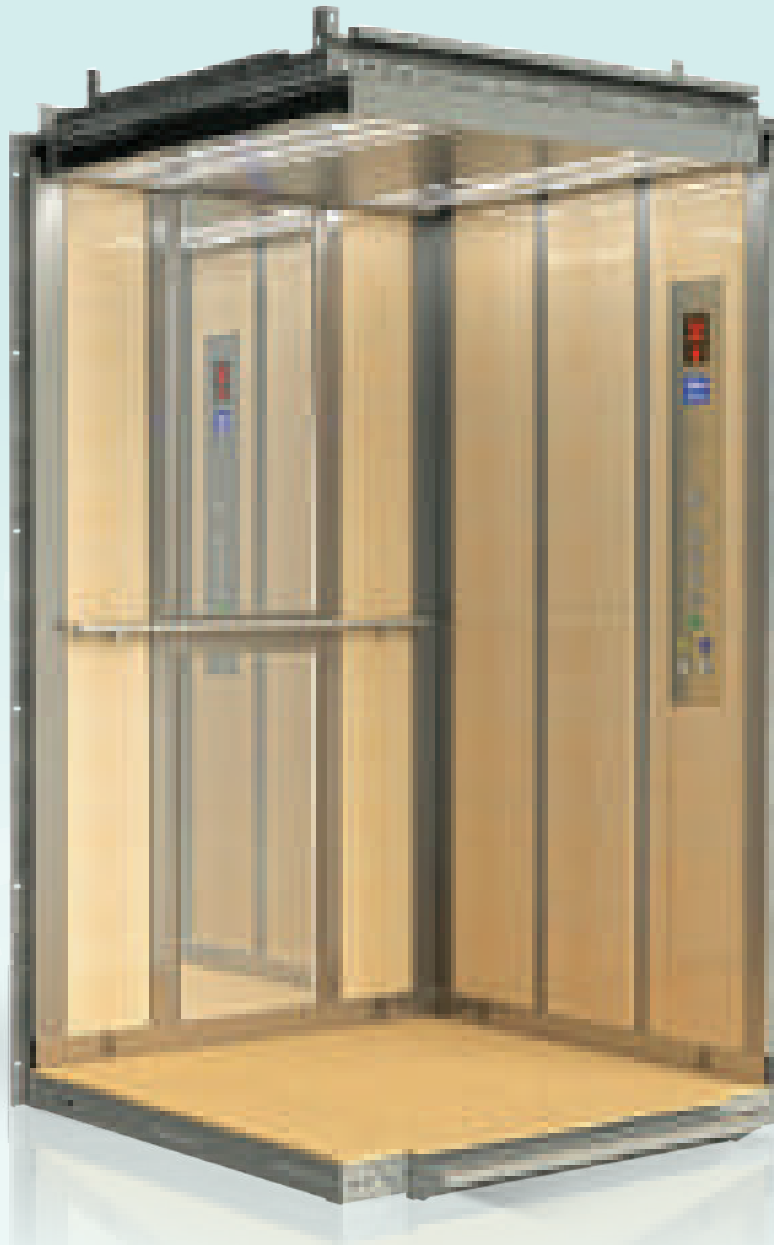

**KBN03**

### KBN 03

|             |                               |
|-------------|-------------------------------|
| Kaplama     | MDF Laminant                  |
| Aksesuar    | Ayna Paslanmaz                |
| Tavan       | Lazer Kesim                   |
| Zemin       | PVC                           |
| Ayna        | Tam Boy Ayna (Dar)            |
| Küpeşte     | Arka Duvarda Tekli            |
| Covering    | MDF Laminate                  |
| Accessories | Mirror Stainless Steel        |
| Ceiling     | Laser Cut                     |
| Floor       | PVC                           |
| Mirror      | Full Height Mirror (Narrow)   |
| Handrail    | Single The Rear Wall          |
| Покрытие    | Ламинат MDF                   |
| Аксессуары  | Зеркальная Нержавеющая Сталь  |
| Потолок     | Лазерная резка                |
| Пол         | PVC                           |
| Зеркало     | Зеркало в Полный Рост (Узкое) |
| Поручень    | На задней стене Одинарный     |

|           |                         |
|-----------|-------------------------|
| التغطية   | ألواح MDF مصقولة        |
| الاكسسوار | ستائنلس ستيل عاكس       |
| السقف     | مقطوع بالليزر           |
| الارضية   | PVC                     |
| المرآة    | نحيفة بارتفاع كامل      |
| الدرابزين | مفردة على الحائط الخلفي |

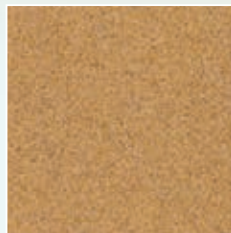

## KBN 04

### KBN 04

|             |                               |
|-------------|-------------------------------|
| Kaplama     | MDF Laminant                  |
| Aksesuar    | Ayna Paslanmaz                |
| Tavan       | Lazer Kesim                   |
| Zemin       | PVC                           |
| Ayna        | Tam Boy Ayna (Dar)            |
| Küpeşte     | Arka Duvarda Tekli            |
| Covering    | MDF Laminate                  |
| Accessories | Mirror Stainless Steel        |
| Ceiling     | Laser Cut                     |
| Floor       | PVC                           |
| Mirror      | Full Height Mirror (Narrow)   |
| Handrail    | Single The Rear Wall          |
| Покрытие    | Ламинат MDF                   |
| Аксессуары  | Зеркальная Нержавеющая Сталь  |
| Потолок     | Лазерная резка                |
| Пол         | PVC                           |
| Зеркало     | Зеркало в Полный Рост (Узкое) |
| Поручень    | На задней стене Одинарный     |
| التغطية     | ألواح MDF مصقولة              |
| الاكسسوار   | ستانلس ستيل عاكس              |
| السقف       | مقطوع بالليزر                 |
| الارضية     | PVC                           |
| المرآة      | نحيفة بارتفاع كامل            |
| الدرايزين   | مفردة على الحائط الخلفي       |

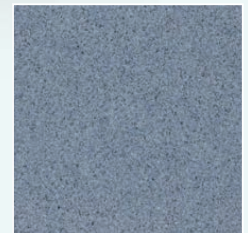
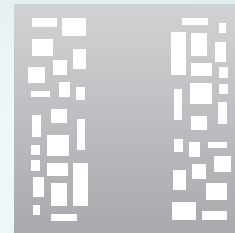



KBN 05

### KBN 05

|             |                                 |
|-------------|---------------------------------|
| Kaplama     | MDF Laminant                    |
| Aksesuar    | Ayna Paslanmaz                  |
| Tavan       | Lazer Kesim                     |
| Zemin       | PVC                             |
| Ayna        | Tam Boy Ayna (Geniş)            |
| Küpeşte     | Arka Duvarda Tekli              |
| Covering    | MDF Laminant                    |
| Accessories | Mirror Stainless Steel          |
| Ceiling     | Laser Cut                       |
| Floor       | PVC                             |
| Mirror      | Full Height Mirror (Wide)       |
| Handrail    | Single The Rear Wall            |
| Покрытие    | Ламинат MDF                     |
| Аксессуары  | Зеркальная Нержавеющая Сталь    |
| Потолок     | Лазерная резка                  |
| Пол         | PVC                             |
| Зеркало     | Зеркало в Полный Рост (Широкое) |
| Поручень    | На задней стене Одинарный       |

|           |                         |
|-----------|-------------------------|
| التغطية   | ألواح MDF مصقولة        |
| الاكسسوار | ستانلس ستيل عاكس        |
| السقف     | مقطوع بالليزر           |
| الارضية   | PVC                     |
| المراة    | عريضة على كامل الارتفاع |
| الدرابزين | مفردة على الحائط الخلفي |

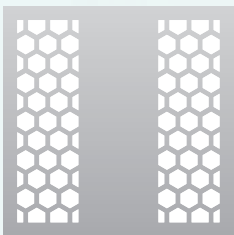



KBN 06

KBN 06

|             |                              |
|-------------|------------------------------|
| Kaplama     | MDF Laminant                 |
| Aksesuar    | Ayna Paslanmaz               |
| Tavan       | Lazer Kesim                  |
| Zemin       | PVC                          |
| Ayna        | Yarım Boy                    |
| Küpeşte     | Arka Duvarda Tekli           |
| Covering    | MDF Laminate                 |
| Accessories | Mirror Stainless Steel       |
| Ceiling     | Laser Cut                    |
| Floor       | PVC                          |
| Mirror      | Half Heigth                  |
| Handrail    | Single The Rear Wall         |
| Покрытие    | Ламинат MDF                  |
| Аксессуары  | Зеркальная Нержавеющая Сталь |
| Потолок     | Лазерная резка               |
| Пол         | PVC                          |
| Зеркало     | В Пол Роста                  |
| Поручень    | На задней стене Одинарный    |
| التغطية     | ألواح MDF مصقولة             |
| الاكسسوار   | ستانلس ستيل عاكس             |
| السقف       | مقطوع بالليزر                |
| الارضية     | PVC                          |
| المرآة      | عريضة بنصف ارتفاع            |
| الدرابزين   | مفردة على الحائط الخلفي      |

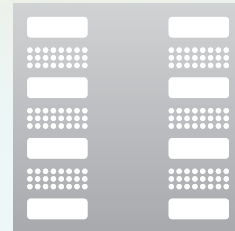



KBN 07

### KBN 07

|             |                                 |
|-------------|---------------------------------|
| Kaplama     | MDF Laminant                    |
| Aksesuar    | Ayna Paslanmaz                  |
| Tavan       | Lazer Kesim                     |
| Zemin       | PVC                             |
| Ayna        | Tam Boy Ayna (Geniş)            |
| Küpeşte     | Arka Duvarda Tekli              |
| Covering    | MDF Laminat                     |
| Accessories | Mirror Stainless Steel          |
| Ceiling     | Laser Cut                       |
| Floor       | PVC                             |
| Mirror      | Full Height Mirror (Wide)       |
| Handrail    | Single The Rear Wall            |
| Покрытие    | Ламинат MDF                     |
| Аксессуары  | Зеркальная Нержавеющая Сталь    |
| Потолок     | Лазерная резка                  |
| Пол         | PVC                             |
| Зеркало     | Зеркало в Полный Рост (Широкое) |
| Поручень    | На задней стене Одинарный       |

|           |                         |
|-----------|-------------------------|
| التغطية   | ألواح MDF مصقولة        |
| الاكسسوار | ستانلس ستيل عاكس        |
| السقف     | مقطوع بالليزر           |
| الارضية   | PVC                     |
| المرآة    | عريضة على كامل الارتفاع |
| الدرابزين | مفردة على الحائط الخلفي |

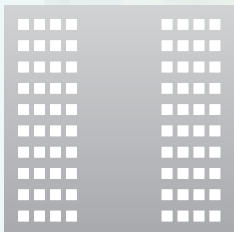

## KBN08

### KBN 08

|                         |                              |
|-------------------------|------------------------------|
| Kaplama                 | Satine Paslanmaz             |
| Aksesuar                | Ayna Paslanmaz               |
| Tavan                   | Lazer Kesim                  |
| Zemin                   | PVC                          |
| Ayna                    | Yarım Boy                    |
| Küpeşte                 | Arka Duvarda Tekli           |
| Covering                | Hairline Stainless Steel     |
| Accessories             | Mirror Stainless Steel       |
| Ceiling                 | Laser Cut                    |
| Floor                   | PVC                          |
| Mirror                  | Half Height                  |
| Handrail                | Single The Rear Wall         |
| Покрытие                | Сатин Нержавеющий            |
| Аксессуары              | Зеркальная Нержавеющая Сталь |
| Потолок                 | Лазерная резка               |
| Пол                     | PVC                          |
| Зеркало                 | В Пол Роста                  |
| Поручень                | На задней стене Одинарный    |
| ستانلس ستيل مطفي        | التغطية                      |
| ستانلس ستيل عاكس        | الاكسسوار                    |
| مقطوع بالليزر           | السقف                        |
| PVC                     | الارضية                      |
| عريضة بنصف ارتفاع       | المرآة                       |
| مفردة على الحائط الخلفي | الدرابزين                    |

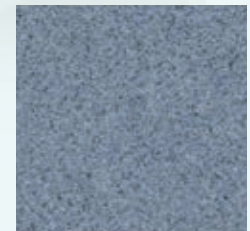
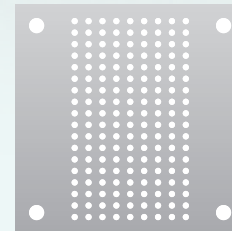



KBN09

### KBN 09

|             |                              |
|-------------|------------------------------|
| Kaplama     | Satine Paslanmaz             |
| Aksesuar    | Ayna Paslanmaz               |
| Tavan       | Lazer Kesim                  |
| Zemin       | PVC                          |
| Ayna        | Yarım Boy                    |
| Küpeşte     | Arka Duvarda Tekli           |
| Covering    | Hairline Stainless Steel     |
| Accessories | Mirror Stainless Steel       |
| Ceiling     | Laser Cut                    |
| Floor       | PVC                          |
| Mirror      | Half Height                  |
| Handrail    | Single The Rear Wall         |
| Покрытие    | Сатин Нержавеющий            |
| Аксессуары  | Зеркальная Нержавеющая Сталь |
| Потолок     | Лазерная резка               |
| Пол         | PVC                          |
| Зеркало     | В Пол Роста                  |
| Поручень    | На задней стене Одинарный    |
| التغطية     | ستانلس ستيل مطفي             |
| الاكسسوار   | ستانلس ستيل عاكس             |
| السقف       | مقطوع بالليزر                |
| الارضية     | PVC                          |
| المرآة      | عريضة بنصف ارتفاع            |
| الدرابزين   | مفردة على الحائط الخلفي      |

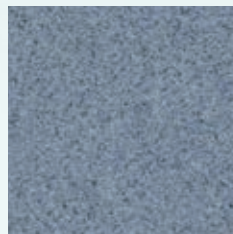
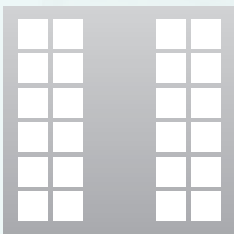

## KBN 10

### KBN 10

|             |                                      |
|-------------|--------------------------------------|
| Kaplama     | Komple Direk Satine Paslanmaz        |
| Aksesuar    | —                                    |
| Tavan       | Lazer Kesim                          |
| Zemin       | PVC                                  |
| Ayna        | Yarım Boy                            |
| Küpeşte     | Arka Duvarda Tekli                   |
| Covering    | Complete Stainless Steel             |
| Accessories | —                                    |
| Ceiling     | Laser Cut                            |
| Floor       | PVC                                  |
| Mirror      | Half Heigth                          |
| Handrail    | Single The Rear Wall                 |
| Покрытие    | Сатиновая Опора из Нержавеющей Стали |
| Аксессуары  | —                                    |
| Потолок     | Лазерная резка                       |
| Пол         | PVC                                  |
| Зеркало     | В Пол Роста                          |
| Поручень    | На задней стене Одинарный            |

|                         |           |
|-------------------------|-----------|
| ستانلس ستيل مطفي خالص   | التغطية   |
| —                       | الاكسسوار |
| مقطوع بالليزر           | السقف     |
| PVC                     | الارضية   |
| عريضة بنصف ارتفاع       | المرآة    |
| مفردة على الحائط الخلفي | الدرابزين |

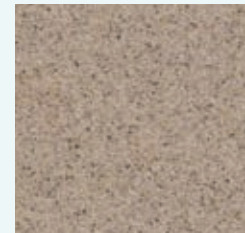
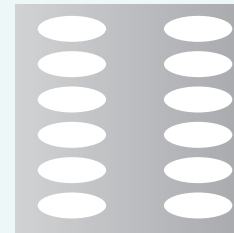





**KBN 11**

**KBN 11**

|             |                              |
|-------------|------------------------------|
| Kaplama     | Satine Paslanmaz             |
| Aksesuar    | —                            |
| Tavan       | Spot                         |
| Zemin       | Satine Paslanmaz             |
| Ayna        | —                            |
| Raf         | Tek Sıra Paslanmaz           |
| Covering    | Hairline Stainless Steel     |
| Accessories | —                            |
| Ceiling     | Spotlight                    |
| Floor       | Hairline Stainless Steel     |
| Mirror      | —                            |
| Shelf       | Single Stainless Steel       |
| Покрытие    | Сатин Нержавеющий            |
| Аксессуары  | —                            |
| Потолок     | Точечное                     |
| Пол         | Сатин Нержавеющий            |
| Зеркало     | —                            |
| Полка       | Однорядная нержавеющая сталь |
| التغطية     | ستانلس ستيل مطفي             |
| الاكسسوار   | —                            |
| السقف       | سبوت                         |
| الارضية     | ستانلس ستيل مطفي             |
| المرآة      | —                            |
| الدرابزين   | رف واحد من الستانليس ستيل    |

## KBN12

### KBN 12

|             |                                 |
|-------------|---------------------------------|
| Kaplama     | Boyalı Lamine Cam               |
| Aksesuar    | Ayna Paslanmaz                  |
| Tavan       | Lazer Kesim                     |
| Zemin       | Doğal Granit                    |
| Ayna        | Tam Boy Ayna (Geniş)            |
| Küpeşte     | Arka Duvarda Tekli              |
| Covering    | Painted Laminated Glass         |
| Accessories | Mirror Stainless Steel          |
| Ceiling     | Laser Cut                       |
| Floor       | Natural Granite                 |
| Mirror      | Full Height Mirror (Wide)       |
| Handrail    | Single in Rear Wall             |
| Покрытие    | Крашеное Ламинированное Стекло  |
| Аксесуары   | Зеркальная Нержавеющая Сталь    |
| Потолок     | Лазерная резка                  |
| Пол         | Натуральный гранит              |
| Зеркало     | Зеркало в Полный Рост (Широкое) |
| Поручень    | На задней стене Одинарный       |
| التغطية     | زجاج على ألواح مطلية            |
| الاكسسوار   | ستانلس ستيل عاكس                |
| السقف       | مقطوع بالليزر                   |
| الارضية     | غرانيت طبيعي                    |
| المرآة      | عريضة على كامل الارتفاع         |
| الدرابزين   | مفردة على الحائط الخلفي         |

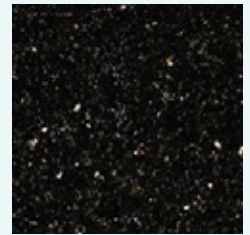
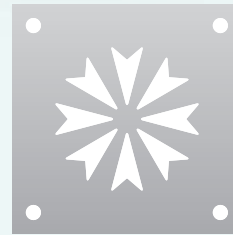



KBN 13

### KBN 13

|             |                                 |
|-------------|---------------------------------|
| Kaplama     | Boyalı Lamine Cam               |
| Aksesuar    | Ayna Paslanmaz                  |
| Tavan       | Lazer Kesim                     |
| Zemin       | Doğal Granit                    |
| Ayna        | Tam Boy Ayna (Geniş)            |
| Küpeşte     | Arka Duvarda Tekli              |
| Covering    | Painted Laminated Glass         |
| Accessories | Mirror Stainless Steel          |
| Ceiling     | Laser Cut                       |
| Floor       | Natural Granite                 |
| Mirror      | Full Height Mirror (Wide)       |
| Handrail    | Single in Rear Wall             |
| Покрытие    | Крашеное Ламинированное Стекло  |
| Аксессуары  | Зеркальная Нержавеющая Сталь    |
| Потолок     | Лазерная резка                  |
| Пол         | Натуральный гранит              |
| Зеркало     | Зеркало в Полный Рост (Широкое) |
| Поручень    | На задней стене Одинарный       |
| التغطية     | زجاج على ألواح مطلية            |
| الاكسسوار   | ستانلس ستيل عاكس                |
| السقف       | مقطع بالليزر                    |
| الارضية     | غرانيت طبيعي                    |
| المرآة      | عريضة على كامل الارتفاع         |
| الدرابزين   | مفردة على الحائط الخفي          |

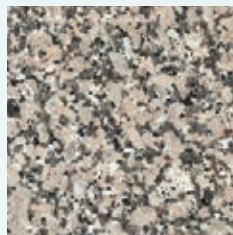
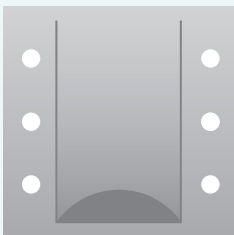

## KBN 14

### KBN 14

|                         |                                |
|-------------------------|--------------------------------|
| Kaplama                 | Dekoratif Paslanmaz            |
| Aksesuar                | Ayna Paslanmaz                 |
| Tavan                   | Lazer Kesim                    |
| Zemin                   | Doğal Granit                   |
| Ayna                    | Yarım Boy Ayna                 |
| Küpeşte                 | Arka Duvarda Tekli             |
| Covering                | Decorative Stainless Steel     |
| Accessories             | Mirror Stainless Steel         |
| Ceiling                 | Laser Cut                      |
| Floor                   | Natural Granite                |
| Mirror                  | Half Height Mirror             |
| Handrail                | Single in Rear Wall            |
| Покрытие                | Декоративная Нержавеющая Сталь |
| Аксессуары              | Зеркальная Нержавеющая Сталь   |
| Потолок                 | Лазерная резка                 |
| Пол                     | Натуральный гранит             |
| Зеркало                 | В Пол Роста                    |
| Поручень                | На задней стене Одинарный      |
| ستانلس ستيل مزخرف       | التغطية                        |
| ستانلس ستيل عاكس        | الاكسسوار                      |
| مقطوع بالليزر           | السقف                          |
| غرانيت طبيعي            | الارضية                        |
| عريضة على نصف الارتفاع  | المرآة                         |
| مفردة على الحائط الخلفي | الدرايزين                      |

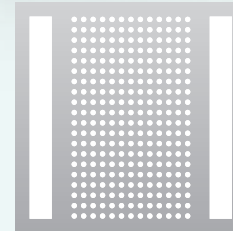



**Dekoratif Kabinler**  
**Decorative Cabins**  
**Декоративные кабины**  
**الكابائن المزخرفة**

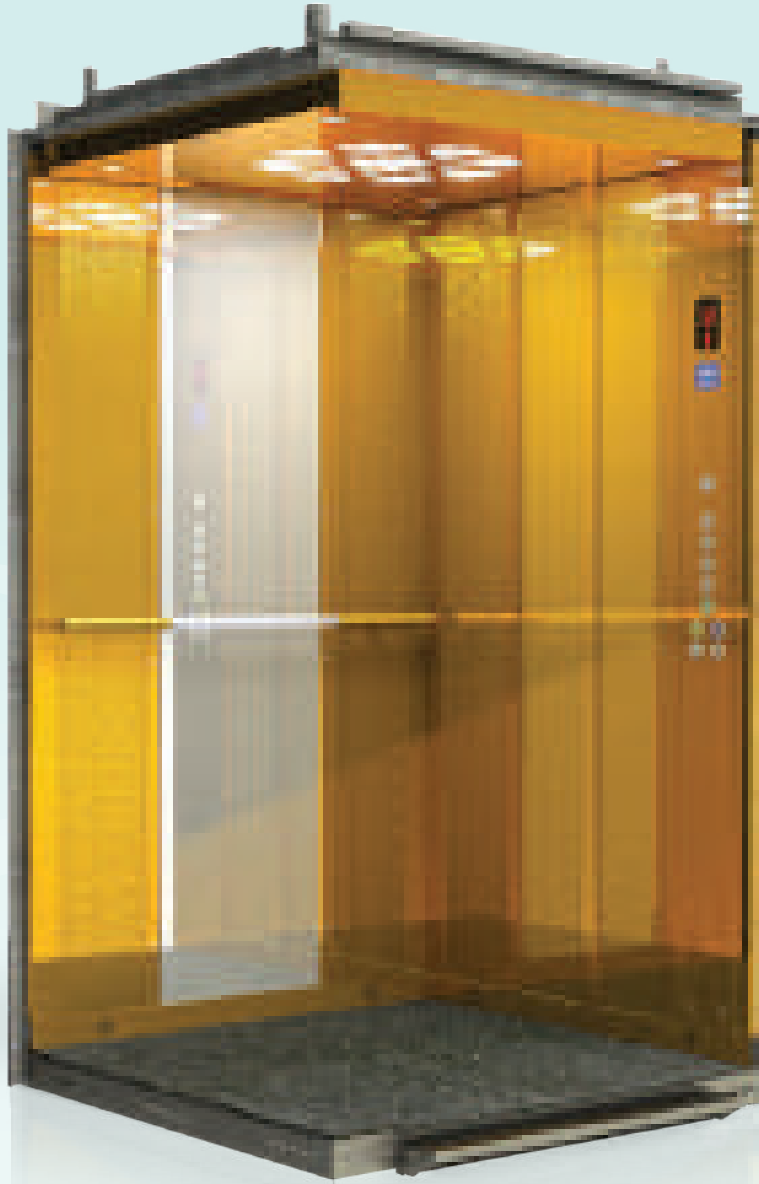

**KBN 15**

**KBN 15**

|             |  |
|-------------|--|
| Kaplama     | Altın Dekoratif Paslanmaz              |
| Aksesuar    | Altın Ayna Paslanmaz                   |
| Tavan       | Lazer Kesim                            |
| Zemin       | Doğal Granit                           |
| Ayna        | Tam Boy Ayna (Dar)                     |
| Küpeşte     | Arka Duvarda Tekli                     |
| Covering    | Gold Decorative Stainless Steel        |
| Accessories | Gold Mirror Stainless Steel            |
| Ceiling     | Laser Cut                              |
| Floor       | Natural Granite                        |
| Mirror      | Full Height Mirror (Narrow)            |
| Handrail    | Single in Rear Wall                    |
| Покрытие    | Золотая Декоративная Нержавеющая Сталь |
| Аксессуары  | Золотое Зеркальная Нержавеющая Сталь   |
| Потолок     | Лазерная резка                         |
| Пол         | Натуральный гранит                     |
| Зеркало     | Зеркало в Полный Рост (Узкое)          |
| Поручень    | На задней стене Одинарный              |
| التغطية     | ستانلس ستيل ذهبي مزخرف                 |
| الاكسسوار   | ستانلس ستيل ذهبي عاكس                  |
| السقف       | مقطوع بالليزر                          |
| الارضية     | غرانيت طبيعي                           |
| المرآة      | نحيفة بارتفاع كامل                     |
| الدرابزين   | مفردة على الحائط الخلفي                |

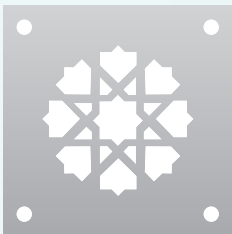

KBN 16

KBN 16

|             |                           |
|-------------|---------------------------|
| Kaplama     | Japon Taşı                |
| Aksesuar    | Süper Ayna Paslanmaz      |
| Tavan       | Lazer Tavan               |
| Zemin       | Doğal Granit              |
| Ayna        | Tam Boy Ayna              |
| Küpeşte     | Arka Duvarda Tekli        |
| Covering    | Japanese Stone            |
| Accessories | Super Mirror STS          |
| Ceiling     | Laser Ceiling             |
| Floor       | Naturel Granite           |
| Mirror      | Full Height Mirror        |
| Handrail    | Single in Rear Wall       |
| Покрытие    | Японский Камень           |
| Аксессуары  | Супер Зеркало Нержавеющее |
| Потолок     | Лазерная резка            |
| Пол         | Натуральный гранит        |
| Зеркало     | Зеркало в Полный Рост     |
| Поручень    | На задней стене Одиночный |

|                              |           |
|------------------------------|-----------|
| أحجار يابانية                | التغطية   |
| ستانلس ستيل عاكس عالي الجودة | الاكسسوار |
| مقطوع بالليزر                | السقف     |
| غرانيت طبيعي                 | الارضية   |
| عريضة على كامل الارتفاع      | المرآة    |
| مفردة على الحائط الخلفي      | الدرايزين |

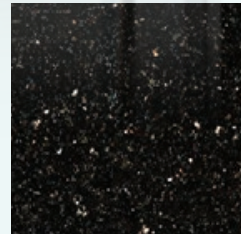
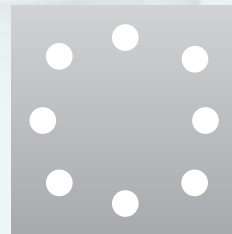

**Dekoratif Kabinler**  
Decorative Cabins  
Декоративные кабины  
الكابائن المزخرفة



KBN 17

**KBN 17**

|             |   |
|-------------|---|
| Kaplama     | 3 Boyutlu MDF Üstü Resim Baskı              |
| Aksesuar    | Ayna Paslanmaz                              |
| Tavan       | 3 Boyutlu Pleksi Üstü Resim Baskı           |
| Zemin       | Doğal Taş Üstü Resim Baskı                  |
| Ayna        | Tam Boy Ayna                                |
| Küpeşte     | Arka Duvarda Tekli                          |
| Covering    | 3D image on MDF                             |
| Accessories | Mirror Stainless Steel                      |
| Ceiling     | 3D image on Plexi                           |
| Floor       | 3D image on Natural Stone                   |
| Mirror      | Full Height Mirror                          |
| Handrail    | Single in Rear Wall                         |
| Покрытие    | 3d Печать на Mdf                            |
| Аksesуары   | Зеркальная Нержавеющая Сталь                |
| Потолок     | 3D Plexi с напечатанным на нем изображением |
| Пол         | Картина напечатана на натуральном камне     |
| Зеркало     | Зеркало в Полный Рост                       |
| Поручень    | На задней стене Одинарный                   |

|           |                             |
|-----------|-----------------------------|
| التغطية   | رسوم ثلاثية الأبعاد         |
| الاكسسوار | ستانلس ستيل عاكس            |
| السقف     | الواح بلاستيكي عليها رسومات |
| الأرضية   | حجر طبيعي عليه رسومات       |
| المرآة    | عريضة على كامل الارتفاع     |
| الدرايزين | مفردة على الحائط الخلفي     |

NOT: Kataloğumuzun 60 ve 61. sayfasında resim seçeneklerinden bazılarını görebilirsiniz. Daha fazlası için satış bölümümüzle irtibata geçiniz.

NOTE: On page 60 and 61 you can find some image options. For full image catalogue please call our sales department.

Вы можете увидеть некоторые варианты изображений на страницах 60 и 61 нашего каталога.

За дополнительной информацией обращайтесь в наш отдел продаж.

ملاحظة: يمكنكم الإطلاع على المزيد من الصور في الصفحات 60 و 61 وللحصول على كاتالوج الصور يمكنكم التواصل معنا

## KBN18

### KBN 18

|             |   |
|-------------|---|
| Kaplama     | Özel Ahşap Mozaik                           |
| Aksesuar    | Bronz Satine Paslanmaz                      |
| Tavan       | Özel Led ve Spot                            |
| Zemin       | Dekoratif Doğal Granit                      |
| Ayna        | Led Aydınlatmalı Ahşap Çerçevesi            |
| Küpeşte     | Arka Duvarda Tekli                          |
| Covering    | Special Wood Mosaic                         |
| Accessories | Bronze Hairline Stainless Steel             |
| Ceiling     | Special Led and Spotlight                   |
| Floor       | Decorative Natural Granite                  |
| Mirror      | Wooden Frame with Led Light                 |
| Handrail    | Single in Rear Wall                         |
| Покрытие    | Специальная Деревянная Мозаика              |
| Аксесуары   | Зеркальная Бронзовая Нержавеющая Сталь      |
| Потолок     | Специальные светодиоды                      |
| Пол         | Декоративный натуральный гранит             |
| Зеркало     | С Светодиодной Подсветкой в Деревянной Раме |
| Поручень    | На задней стене Одинарный                   |

موزاييك من الخشب الخاص

التغطية

ستانلس ستيل برونزي عاكس

الاكسسوار

سيوت وليد خاص

السقف

گرانيت طبيعي مزخرف

الارضية

باطار خشبي وإضاءة مخفية

المرآة

مفردة على الحائط الخلفي

الدرابزين

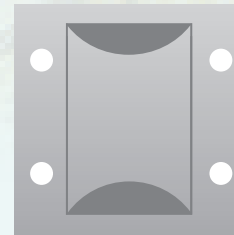



**Özel Tasarım Kabinler**  
**Special Designed Cabins**  
 Специально разработанные кабины  
 الكبائن ذات التصميم الخاصة



**KBN19**

**KBN 19**

|             |  |
|-------------|--|
| Kaplama     | Özel Dekoratif Ahşap Mobilya               |
| Aksesuar    | Bronz Ayna Paslanmaz                       |
| Tavan       | Lazer Kesim Led Aydınlatma                 |
| Zemin       | Dekoratif Doğal Granit                     |
| Ayna        | Tam Boy Ayna                               |
| Küpeşte     | Arka Duvarda Tekli                         |
| Covering    | Special Decorative Wood Furniture          |
| Accessories | Bronze Mirror Stainless Steel              |
| Ceiling     | Laser Cut With Led Light                   |
| Floor       | Decorative Natural Granite                 |
| Mirror      | Full Height Mirror                         |
| Handrail    | Single in Rear Wall                        |
| Покрытие    | Специальная Декоративная Деревянная Мебель |
| Аксессуары  | Зеркальная Бронзовая Нержавеющая Сталь     |
| Потолок     | Светодиодное освещение лазерной резки      |
| Пол         | Декоративный натуральный гранит            |
| Зеркало     | Зеркало в Полный Рост                      |
| Поручень    | На задней стене Одинарный                  |
| التغطية     | زخارف خشبية خاصة                           |
| الاكسسوار   | ستانلس ستيل برونزي عاكس                    |
| السقف       | قطع ليزر مع إضاءة ليد                      |
| الارضية     | غرانيت طبيعي مزخرف                         |
| المرآة      | عريضة على كامل الارتفاع                    |
| الدرابزين   | مفردة على الحائط الخلفي                    |

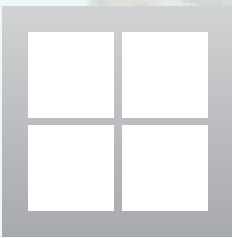

KBN 20

KBN 20

|                    |                              |
|--------------------|------------------------------|
| Kaplama            | Satine Paslanmaz             |
| Aksesuar           | Ayna Paslanmaz               |
| Tavan              | Lazer Kesim                  |
| Zemin              | Anti-Bakteriyel PVC          |
| Ayna               | -                            |
| Koruma Banti       | Tek Sıra Ahşap               |
| Covering           | Hairline Stainless Steel     |
| Accessories        | Mirror Stainless Steel       |
| Ceiling            | Laser Cut                    |
| Floor              | Anti-Bacterial PVC           |
| Mirror             | -                            |
| Bumper             | Laminate Single              |
| Покрытие           | Сатин Нержавеющий            |
| Аксессуары         | Зеркальная Нержавеющая Сталь |
| Потолок            | Лазерная резка               |
| Пол                | Антибактериальный PVC        |
| Зеркало            | -                            |
| Защитная лента     | Однорядная дерево            |
| ستانلس ستیل مطفي   | التغطية                      |
| ستانلس ستیل عاكس   | اكسسوارات                    |
| مقطوع بالليزر      | السقف                        |
| PVC مضادة للجراثيم | الارضية                      |
| -                  | المراة                       |
| مفردة صف واحد      | أشرطة الحماية                |

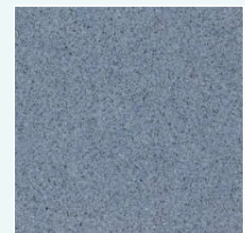
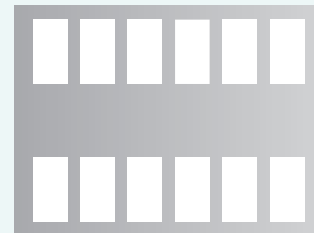

**Sedye ve Yük Kabini**  
Hospital and Freight Cabins  
Носилки и грузовые кабины  
كباين المشافي والأحمال

**KBN 21**



**KBN 21**

|                |                              |               |
|----------------|------------------------------|---------------|
| Kaplama        | RAL Boya Sac                 |               |
| Aksesuar       | RAL Boyalı                   |               |
| Tavan          | RAL Boyalı Spot              |               |
| Zemin          | Baklavalı Sac                |               |
| Ayna           | -                            |               |
| Koruma Bantı   | Çift Sıra Ahşap              |               |
| Covering       | RAL painted Steel            |               |
| Accessories    | RAL Painted                  |               |
| Ceiling        | RAL Painted Spotlight        |               |
| Floor          | Chaker Plate                 |               |
| Mirror         | -                            |               |
| Bumper         | Laminate Double              |               |
| Покрытие       | Лист Краски Ral              |               |
| Аксесуары      | Окрашенный Ral               |               |
| Потолок        | Светодиод с покраской RAL    |               |
| Пол            | Лист с рисунком в виде ромба |               |
| Зеркало        | -                            |               |
| Защитная лента | Двухрядное дерево            |               |
|                | دهان صاج ماركة RAL           | التغطية       |
|                | دهان ماركة RAL               | اكسسوارات     |
|                | دهان سبوت ماركة RAL          | السقف         |
|                | صاج على شكل بقلوة            | الارضية       |
|                | -                            | المرآة        |
|                | مزودة من الخشب               | أشرطة الحماية |

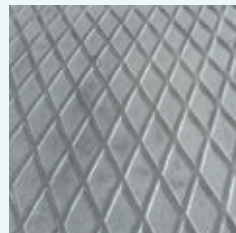

KBN 22

KBN 22

|                                 |   |
|---------------------------------|---|
| Kaplama                         | Lamine Camlı Kare Panoramik                   |
| Aksesuar                        | Satine Paslanmaz                              |
| Tavan                           | Lazer Kesim                                   |
| Zemin                           | Doğal Granit                                  |
| Ayna                            | Projeye Göre...                               |
| Küpeşte                         | Cam Önü Tek Sıra                              |
| Covering                        | Laminated Glass Square Panoramic              |
| Accessories                     | Hairline Stainless Steel                      |
| Ceiling                         | Laser Cut                                     |
| Floor                           | Natural Granite                               |
| Mirror                          | According to Project...                       |
| Handrail                        | Single in Front of Glass                      |
| Покрытие                        | Квадратная Панорама из Ламинированного Стекла |
| Аксессуары                      | Сатин Нержавеющий                             |
| Потолок                         | Лазерная резка                                |
| Пол                             | Натуральный гранит                            |
| Зеркало                         | По Проекту...                                 |
| Поручень                        | Перед Стеклом – Один Ряд Тек                  |
| تجاج ارضية ذو شكل مربع بانورامي | التغطية                                       |
| ستانلس ستیل مطفي                | الاكسسوار                                     |
| مقطوع بالليزر                   | السقف   |
| گرانیت طبیعی                    | الارضية                                       |
| حسب المشروع                     | المرآة  |
| مفردة على الحائط الزجاجي        | الدرابزين                                     |

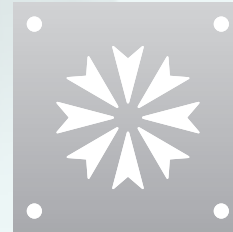

**Not:**  
Panoramik kabin tasarımları  
müşteri talebine göre projelendirilmektedir.

**Note:** Panoramic cabins are being designed  
according to customer desires.



## Panoramik Kabinler

Panoramic Cabins

Панорамные кабины

الكابائن البانورامية

KBN 23



### KBN 23

|             |   |
|-------------|---|
| Kaplama     | Lamine Camlı Oval/Mantar Panoramik          |
| Aksesuar    | Ayna Paslanmaz                              |
| Tavan       | Lazer Kesim                                 |
| Zemin       | Doğal Granit                                |
| Ayna        | Projeye Göre...                             |
| Küpeşte     | Cam Önü Tek Sıra                            |
| Covering    | Laminated Glass Oval/Mushroom Panoramic     |
| Accessories | Mirror Stainless Steel                      |
| Ceiling     | Laser Cut                                   |
| Floor       | Natural Granite                             |
| Mirror      | According to Project...                     |
| Handrail    | Single in Front of Glass                    |
| Покрытие    | Ламинированное Стекло Овал. / Панорама-Гриб |
| Аксессуары  | Зеркало из Нержавеющей Стали                |
| Потолок     | Лазерная резка                              |
| Пол         | Натуральный гранит                          |
| Зеркало     | По Проекту...                               |
| Поручень    | Перед Стеклом – Один Ряд Тек                |

|           |                         |
|-----------|-------------------------|
| التغطية   | جدار من الزجاج البيضاوي |
| الاكسسوار | ستانلس ستيل عاكس        |
| السقف     | مقطع بالليزر            |
| الارضية   | غرانيت طبيعي            |
| المراة    | حسب المشروع             |
| الدرابزين | حسب المشروع             |

Панорамный дизайн кабины проектируется по желанию заказчика.

ملاحظة: يتم تصميم المقصورات البانورامية بناءاً على رغبات عملائنا

## Boyalı Panoramik Kabin

Painted Panoramic Cabinet

Окрашенная Панорамная Кабина

مقصورة بانورامية مطلية

KBN 24

### KBN 24

|                      |   |
|----------------------|---|
| Kaplama              | RAL Pütürlü Boya Döşeme   |
| Aksesuar             | RAL Pütürlü Boya  |
| Tavan                | RAL Pütürlü Led ve Spot   |
| Zemin                | Doğal Granit  |
| Ayna                 | -   |
| Küpeşte              | Cam Önü Sac Boyalı  |
| Covering             | RAL Textured Paint Flooring   |
| Accessories          | RAL Textured Paint  |
| Ceiling              | RAL Textured Led and Spotlights                                     |
| Floor                | Natural Granite   |
| Mirror               | -   |
| Handrail             | Window Front with Painted Sheet                                     |
| Покрытие             | Шероховатая краска для пола RAL                                     |
| Аксессуары           | Шероховатая краска RAL  |
| Потолок              | Шероховатые светодиодные лампочки (Led) и Точечное освещение (Spot) |
| Пол                  | Натуральный гранит  |
| Зеркало              | -   |
| Поручень             | Окрашенный лист для стеклянного фасада                              |
| فرش طلاء خشن RAL     | التغطية   |
| طلاء خشن RAL         | الاكسسوار   |
| مصباح وكشاف خشن RAL  | السقف   |
| غرانيت طبيعي         | الارضية   |
| -                    | المرآة  |
| لوح أمام الزجاج مطلي | الدرابزين   |

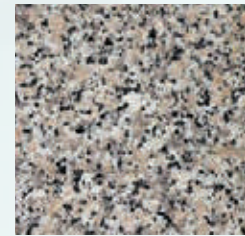

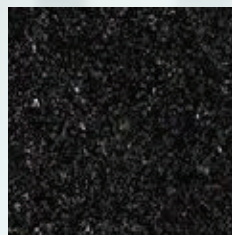

**Özel Pütürlü Boyalı Kabin**  
**Cabinet With Special Textured Paint**  
 Специальная Шероховато Окрашенная Кабина  
 مقصورة بطلاء حشن خاص

**KBN 25**

**KBN 25**

|             |                            |           |
|-------------|----------------------------|-----------|
| Kaplama     | RAL Boya Döşeme            |           |
| Aksesuar    | RAL Boyalı                 |           |
| Tavan       | RAL Boyalı Led             |           |
| Zemin       | Doğal Granit               |           |
| Ayna        | Arkada Tam Boy             |           |
| Küpeşte     | Arka Duvarda Tekli         |           |
| Covering    | RAL Paint Flooring         |           |
| Accessories | RAL Painted                |           |
| Ceiling     | RAL Painted Led            |           |
| Floor       | Natural Granite            |           |
| Mirror      | Full Size at the Back Side |           |
| Handrail    | Single The Rear Wall       |           |
| Покрытие    | Краска для пола RAL        |           |
| Аксессуары  | Окрашенный RAL             |           |
| Потолок     | Светодиод с покраской RAL  |           |
| Пол         | Натуральный гранит         |           |
| Зеркало     | —                          |           |
| Поручень    | Двухрядное дерево          |           |
|             | فرش طلاء RAL               | التغطية   |
|             | دهان ماركة RAL             | الاكسسوار |
|             | مصباح بطلاء RAL            | السقف     |
|             | غرانيت طبيعي               | الارضية   |
|             | طول كامل بالخلف            | المراة    |
|             | مفردة على الحائط الخلفي    | الدرابزين |

## Boyalı Camlı Kabin

Cabinet With Painted Glass

Окрашенная Стеклянная Кабина

مقصورة زجاجية مطلية

KBN 26

### KBN 26

|             |                                  |
|-------------|----------------------------------|
| Kaplama     | Boyalı Lamine Cam                |
| Aksesuar    | Sarı Satine Paslanmaz            |
| Tavan       | Lazer Kesim                      |
| Zemin       | Doğal Granit                     |
| Ayna        | Tam Boy Arkada                   |
| Küpeşte     | Arka Duvarda Tekli               |
| Covering    | Painted Laminated Glass          |
| Accessories | Stainless Yellow Satine          |
| Ceiling     | Laser Cut                        |
| Floor       | Natural Granite                  |
| Mirror      | Full Size at the Back Side       |
| Handrail    | Single The Rear Wall             |
| Покрытие    | Крашеное Ламинированное Стекло   |
| Аксессуары  | Желтый сатин(Satine) нержавеющей |
| Потолок     | Лазерная резка                   |
| Пол         | Натуральный гранит               |
| Зеркало     | Сзади в полный рост              |
| Поручень    | На задней стене Одинарный        |
| تغطية       | زجاج على ألواح مطلية             |
| الاكسسوار   | صاج أصفر مقاوم للصدأ             |
| السقف       | مقطوع بالليزر                    |
| الارضية     | غرانيت طبيعي                     |
| المرآة      | طول كامل بالخلف                  |
| الدرابزين   | مفردة على الحائط الخلفي          |

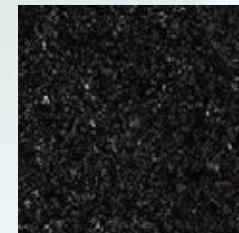



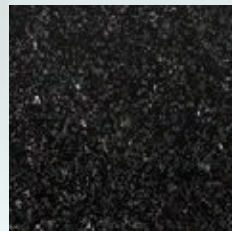
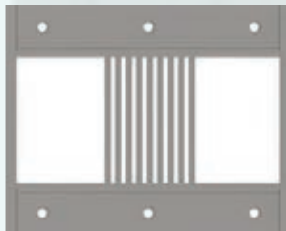

## Özel Tasarım Kabin

Special Design Cabinet

Кабина Специального Дизайна

مقصورة بتصميم خاص

KBN 27

### KBN 27

|             |                             |
|-------------|-----------------------------|
| Kaplama     | Siyah Ayna Paslanmaz        |
| Aksesuar    | Satine paslanmaz            |
| Tavan       | Lazer Kesim                 |
| Zemin       | Doğal Granit                |
| Ayna        | -                           |
| Küpeşte     | Arka Duvarda Tekli          |
| Covering    | Stainless Black Mirror      |
| Accessories | Hairline Stainless Steel    |
| Ceiling     | Laser Cut                   |
| Floor       | Natural Granite             |
| Mirror      | -                           |
| Handrail    | Single The Rear Wall        |
| Покрытие    | Черное зеркало, нержавеющей |
| Аксессуары  | Сатин Нержавеющий           |
| Потолок     | Лазерная резка              |
| Пол         | Натуральный гранит          |
| Зеркало     | -                           |
| Поручень    | На задней стене Одинарный   |
| التغطية     | مرآة سوداء مقاومة للصدا     |
| الاكسسوار   | ستانلس ستيل مطفي            |
| السقف       | مقطع بالليزر                |
| الارضية     | غرانيت طبيعي                |
| المرآة      | -                           |
| الدرابزين   | مفردة على الحائط الخلفي     |

**MDF Laminant Kabin**  
MDF Laminate Cabinet  
Кабина Из Ламината МДФ  
مقصورة بألواح

KBN 28

KBN 28

|                            |                                 |
|----------------------------|---------------------------------|
| Kaplama                    | MDF Laminant                    |
| Aksesuar                   | Ayna Paslanmaz                  |
| Tavan                      | MDF ve Spot                     |
| Zemin                      | Doğal Granit                    |
| Ayna                       | -                               |
| Küpeşte                    | Arka ve Yan Duvarda             |
| Covering                   | MDF Laminate                    |
| Accessories                | Mirror Stainless Steel          |
| Ceiling                    | MDF and Spotlights              |
| Floor                      | Natural Granite                 |
| Mirror                     | -                               |
| Handrail                   | On the Back and Side Wall       |
| Покрытие                   | Ламинат MDF                     |
| Аксессуары                 | Зеркальная Нержавеющая Сталь    |
| Потолок                    | МДФ и Точечное освещение (Spot) |
| Пол                        | Натуральный гранит              |
| Зеркало                    | -                               |
| Поручень                   | На задней и боковой стенках     |
| ألواح مصقولة MDF           | التغطية                         |
| ستانلس ستيل عاكس           | الاكسسوار                       |
| MDF وكشاف                  | السقف                           |
| غرانيت طبيعي               | الارضية                         |
| -                          | المرآة                          |
| على الحائط الخلفي والجانبی | الدرابزين                       |

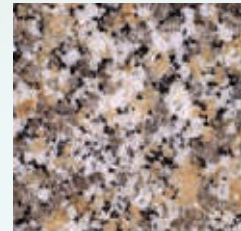



**Капітар** Doors Двери  
الابواب

# ida

المصاعد

lift

asansör

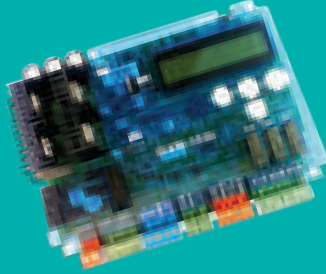

## ida Tam otomatik asansör kapıları özellikleri

TR

- Yüksek kalite
- Emniyet
- Uzun ömür
- Kapı kontrol kartı: Arkel KM-10 veya KM 30S
- Yoğun trafikte sorunsuz ve ısınmadan çalışma
- Sessiz ve konforlu çalışma
- Kabin operatörü motoru: Dunker(Alman) 24V veya Arkel Senkron kapı motoru
- Birinci sınıf ara malzemeler (makaralar, patenler, halat vs.)
- E120 ve E145 yangın belgeleri
- Fiş kontaklar: Pizzato (İtalya)
- Ayarlanabilir açma ve kapama hızları
- Mukavemetli kasa ve paneller
- Panel ve kasada perçinsiz paslanmaz kaplama detayı
- Ral boyalı, paslanmaz, desenli paslanmaz ve camlı kapı seçenekleri
- Ürün ve model çeşitliliği
- 3 yönlü panel ayar imkanı

## ida Automatic lift doors advantages

EN

- *High quality*
- *Safety and reliability*
- *Durable and long-lived*
- *Door control board: Arkel KM-10 or KM-30S (Turkey)*
- *Seamless even in heavy operation without overheating*
- *Noiseless and comfort operation*
- *Cabin operator motor: Dunker (Germany) 24V or Arkel Synchronous door motor*
- *First quality semi parts (rollers, ropes, skate, guides etc.)*
- *E120 AND E145 fire resistance certificates*
- *Contacts: Pizzato (Italy)*
- *Adjustable open/close speeds*
- *Strong frames and panels with endurance*
- *Stainless steel covered frames and panels without clinch*
- *RAL painted, stainless, patterned stainless, and glass door options*
- *Wide range of products and models*
- *3 way panel adjustment ability*

## ida Характеристики полностью автоматических дверей лифта

RU

- Высокое качество
- Безопасность
- Длительная служба
- Карта контроля двери: Arkel KM-10 или KM 30S
- Работает плавно и без нагрева в условиях интенсивного движения
- Тихая и комфортная работа
- Электродвигатель привода кабины: Dunker (немецкий) 24 V или синхронный электродвигатель двери Arkel
- Первокласные промежуточные материалы (шкивы, коньки, канат и т. д.)
- Сертификаты пожарной безопасности E120 и E145
- Штекерные контакты: Pizzato (Италия)
- Регулируемая скорость открытия и закрытия
- Прочная рама и панели
- Деталь из нержавеющей стали без заклепок на панели и раме.
- Варианты дверей из окрашенной, нержавеющей, узорчатой нержавеющей стали и стеклянных дверей
- Разнообразие продуктов и моделей
- Возможность регулировки панели в трех направлениях

# Kapılar Doors Двери الابواب

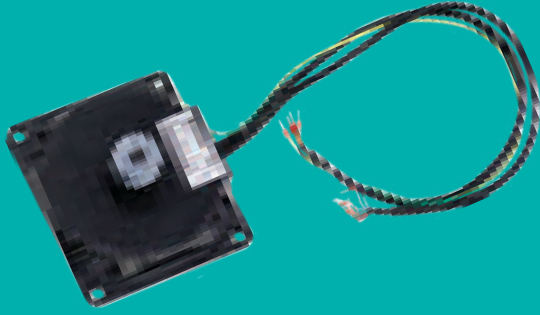

## AR ida ابواب مصاعد اوتوماتيكية كاملة

- امان
- جودة عالية
- الديمومة
- كارت التحكم بالباب: KM-10 أو KM-30S لشركة Arkel التركية
- يعمل دون اي مشاكل وحرارة عند كثرة الاستخدام
- يعمل بشكل مريح وبدون صوت
- موتور الباب الداخلي هو Dunker الألماني أو الموتور الجيرليس Arkel
- موتور الباب الداخلي هو Dunker (ألماني) 24v أو الموتور الجيرليس Arkel
- المواد المصنعة من درجة اولى (بكرات، زلاجات، اسلاك وغيرها)
- شهادات التصنيع المضاد للحرائق E120 و E145
- الفيش كونتاكت ماركة Pizzato الإيطالية
- سرعة الإغلاق والفتح قابلة للمعايرة
- إطارات وألواح عالية المقاومة
- البواري والمقاطع ليس فيها تباشيم ذات غلاف لا يصدأ
- أبواب مطلية، ستانلس ستيل، ستانلس ستيل مزخرف، زجاجية.
- خيارات وموديلات متعددة
- يمكن معايير الألواح في الاتجاهات الثلاثة



## 2 PANEL TELESKOPİK KAT KAPISI

2 PANEL SIDE OPENING LANDING DOOR

2-УХ ПАНЕЛЬНАЯ ТЕЛЕСКОПИЧЕСКАЯ ДВЕРЬ ШАХТЫ

باب خارجي درفتين جانبي

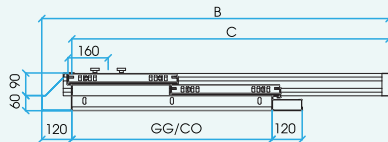
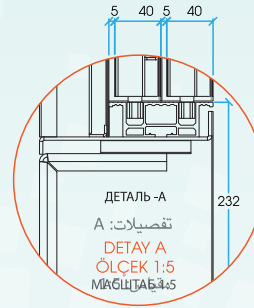
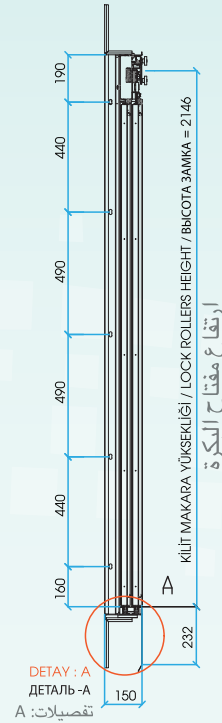
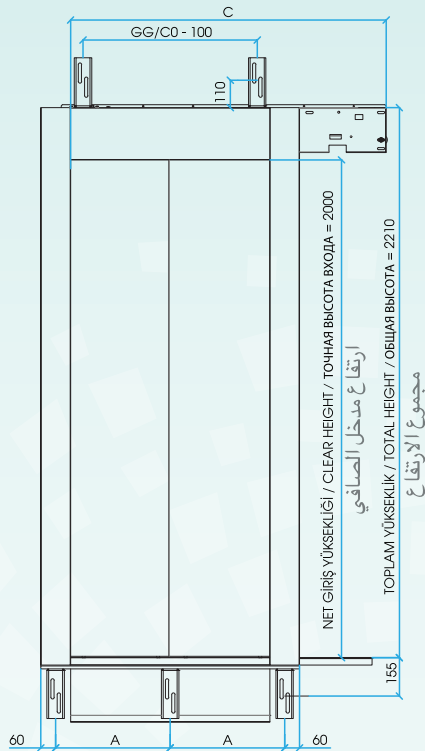
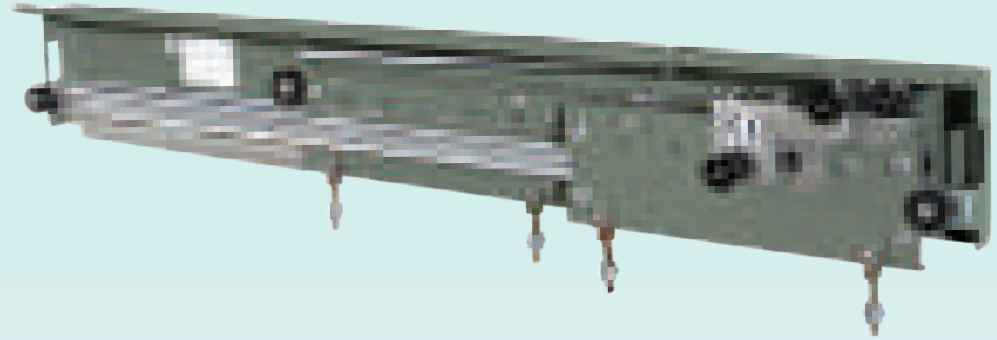

GİRİŞ GENİŞLİĞİ = GG  
CLEAR OPENING = CO  
ШИРИНА ВХОДА = GG  
GG: اتساع المدخل

|          | 600  | 700  | 800  | 900  | 1000 | 1100 | 1200 | 1300 |
|----------|------|------|------|------|------|------|------|------|
| <b>A</b> | 360  | 410  | 460  | 510  | 560  | 610  | 660  | 710  |
| <b>B</b> | 1090 | 1240 | 1390 | 1540 | 1690 | 1840 | 1990 | 2140 |
| <b>C</b> | 970  | 1120 | 1270 | 1420 | 1570 | 1720 | 1870 | 2020 |

## 2 PANEL TELESKOPIK KABİN KAPISI (EN81-1)

### 2 PANEL SIDE OPENING CAR DOOR (EN81-1)

### 2-УХ ПАНЕЛЬНАЯ ТЕЛЕСКОПИЧЕСКАЯ ДВЕРЬ КАБИНЫ (EN81-1)

### باب داخلي درفتين جانبي (EN81-1)

## Kapılar Doors Двери الأبواب

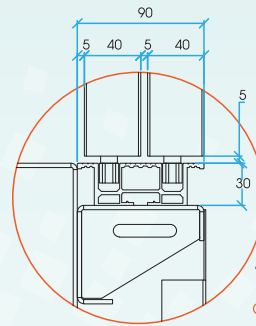
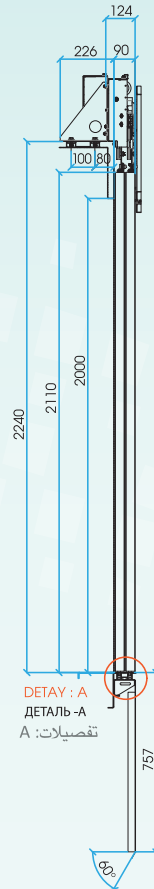
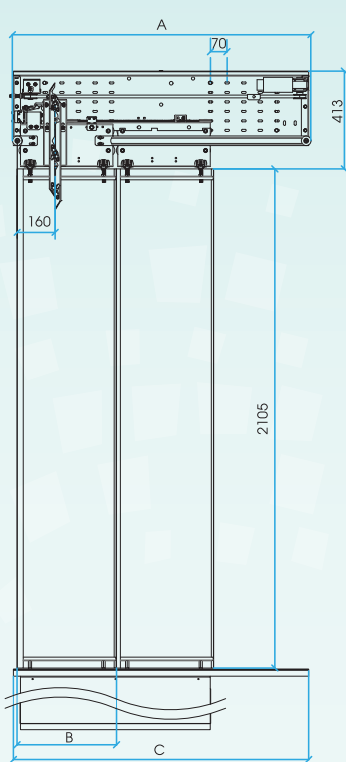
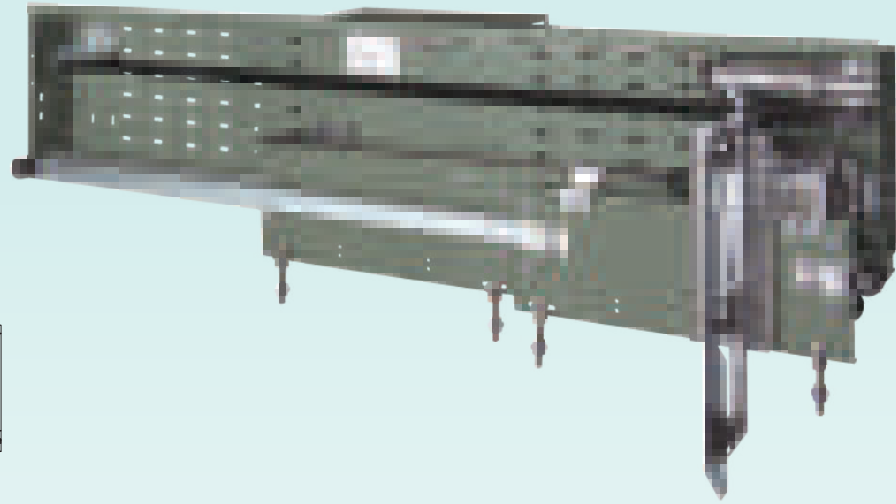

ДЕТАЛЬ -А  
МАСШТАБ 1:5  
A : تفصيلات  
DETAY A  
ÖLÇEK 1:5  
مقياس: 1:5

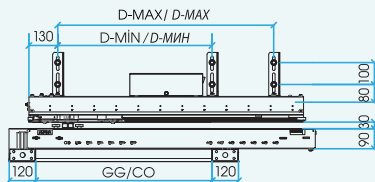

GİRİŞ GENİRLİĞİ = GG  
CLEAR OPENING = CO  
ШИРИНА ВХОДА = GG  
اتساع المدخل = GG

|  | 600 | 700  | 800  | 900  | 1000 | 1100 | 1200 | 1300 |
|--|-----|------|------|------|------|------|------|------|
| <b>A</b>                                 | 960 | 1110 | 1260 | 1410 | 1560 | 1710 | 1860 | 2010 |
| <b>B</b>                                 | 320 | 370  | 420  | 470  | 520  | 570  | 620  | 670  |
| <b>C</b>                                 | 945 | 1095 | 1245 | 1395 | 1545 | 1695 | 1845 | 1995 |
| <b>D-MIN / D-МИН</b><br>اصغري -D         | 540 | 620  | 700  | 780  | 860  | 940  | 1020 | 1100 |
| <b>D-MAX / D-МАХ</b><br>اعظمي -D         | 680 | 830  | 980  | 1130 | 1280 | 1430 | 1580 | 1730 |
| <b>AĞIRLIK / WEIGHT / МАССА</b><br>الوزن |     |      |      |      |      |      |      |      |

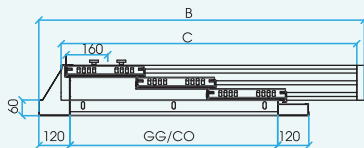
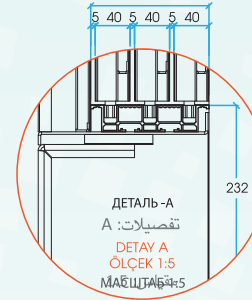
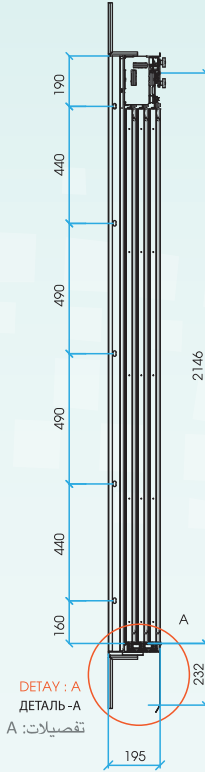
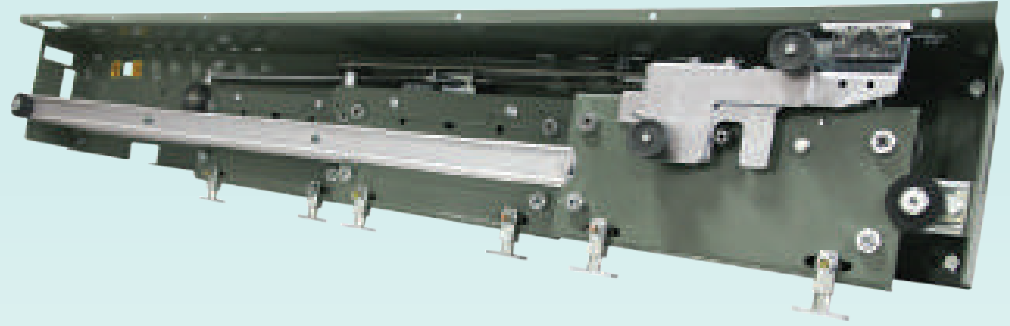

GİRİŞ GENİŞLİĞİ = GG  
CLEAR OPENING = CO  
ШИРИНА ВХОДА = GG  
اتساع المدخل = GG

|          | 700  | 800  | 900  | 1000 | 1100 |
|----------|------|------|------|------|------|
| <b>A</b> | 410  | 460  | 510  | 560  | 610  |
| <b>B</b> | 1125 | 1255 | 1390 | 1520 | 1655 |
| <b>C</b> | 1010 | 1140 | 1275 | 1405 | 1540 |

### 3 PANEL TELESKOPİK KABİN KAPISI (EN81-1)

3 PANEL SIDE OPENING CAR DOOR (EN81-1)

3-ЕХ ПАНЕЛЬНАЯ ТЕЛЕСКОПИЧЕСКАЯ ДВЕРЬ КАБИНЫ (EN81-1)

باب داخلي ثلاث درف جانبي (EN81-1)

Kapılar Doors Двери الأبواب

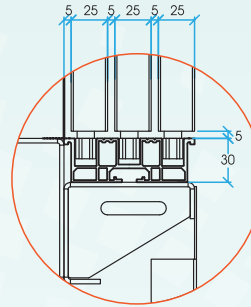
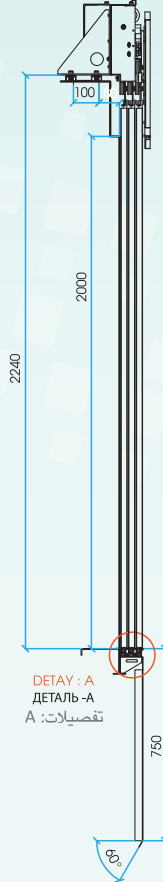
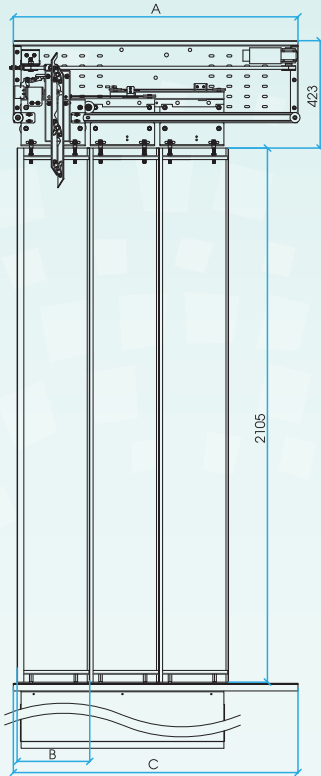
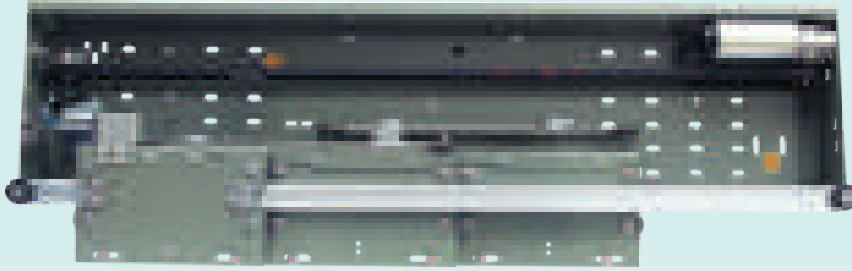

ДЕТАЛЬ - А  
МАСШТАБ 1:5  
A: تفصیلات  
ДЕТАЛЬ - А  
ÖLÇEK 1:5  
مقياس: 1:5

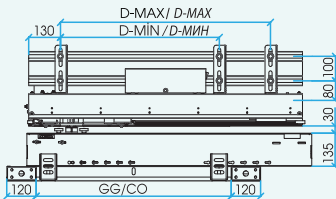

GİRİŞ GENİŞLİĞİ = GG  
CLEAR OPENING = CO  
ШИРИНА ВХОДА = GG  
اتساع المدخل: GG

|  | 700  | 800  | 900  | 1000 | 1100 |
|--|------|------|------|------|------|
| <b>A</b>                                 | 1015 | 1125 | 1255 | 1390 | 1525 |
| <b>B</b>                                 | 253  | 286  | 320  | 353  | 385  |
| <b>C</b>                                 | 1015 | 1125 | 1255 | 1390 | 1525 |
| <b>D-MIN / D-MIN</b><br>D-اصغري          | 582  | 651  | 777  | 903  | 1029 |
| <b>D-MAX / D-MAX</b><br>D-اعظمي          | 722  | 860  | 987  | 1113 | 1239 |
| <b>AĞIRLIK / WEIGHT / МАССА</b><br>الوزن | 67   | 76   | 85   | 94   | 105  |

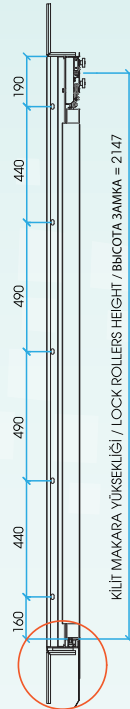
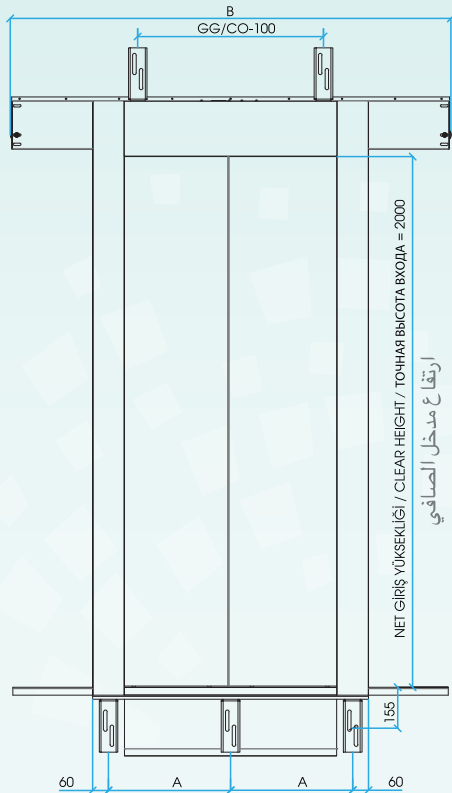
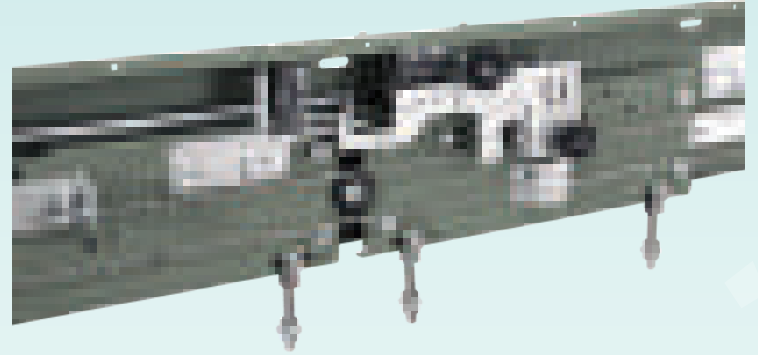
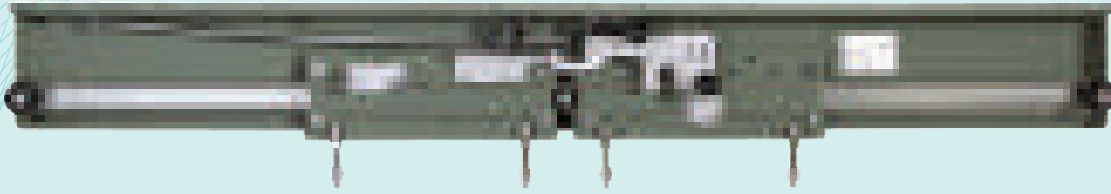

ДЕТАЛЬ - А  
ДЕТАЛЬ - А  
A: تفصيلات

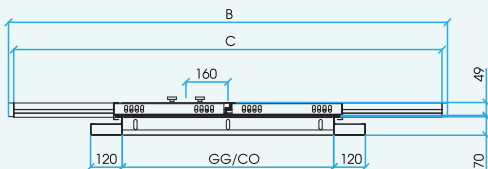
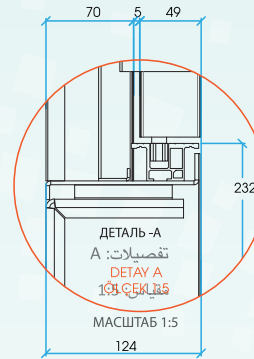

GİRİŞ GENİŞLİĞİ = GG  
CLEAR OPENING = CO  
ШИРИНА ВХОДА = GG  
اتساع المدخل = GG

|          | 600  | 700  | 800  | 900  | 1000 | 1100 | 1200 | 1300 |
|----------|------|------|------|------|------|------|------|------|
| <b>A</b> | 360  | 410  | 460  | 510  | 560  | 610  | 660  | 710  |
| <b>B</b> | 1250 | 1450 | 1650 | 1850 | 2050 | 2250 | 2450 | 2650 |
| <b>C</b> | 1240 | 1440 | 1640 | 1840 | 2040 | 2240 | 2440 | 2640 |



## 2 PANEL MERKEZİ KABİN KAPISI (EN81-1)

2 PANEL CENTRAL OPENING CAR DOOR (EN81-1)

2-УХ ПАНЕЛЬНАЯ ЦЕНТРАЛЬНАЯ ДВЕРЬ КАБИНЫ (EN81-1)

باب داخلي درفتين مركزي (EN81-1)

Kapılar Doors Двери الأبواب

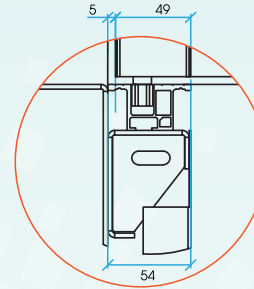
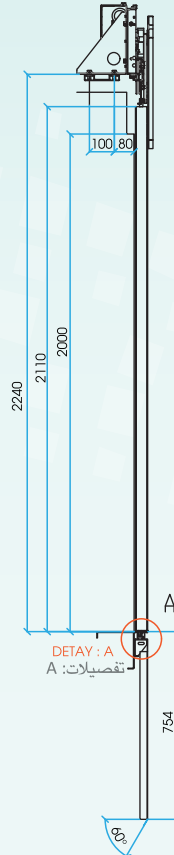
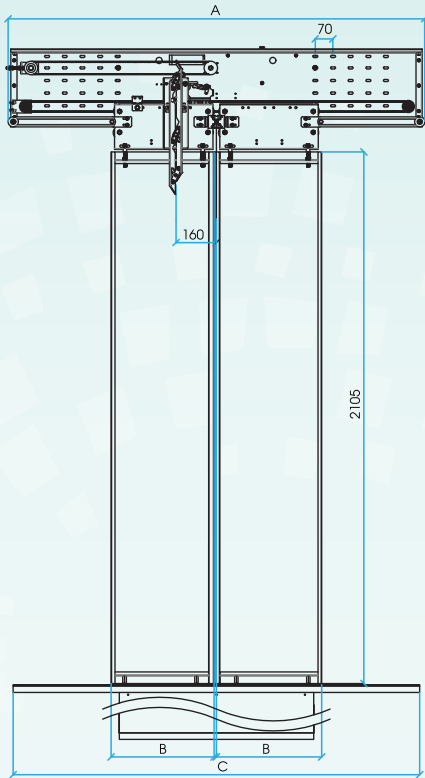
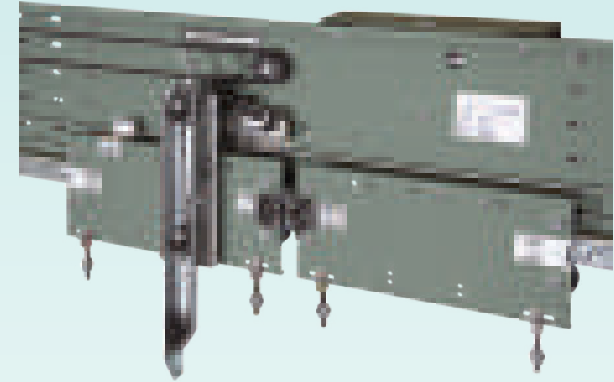
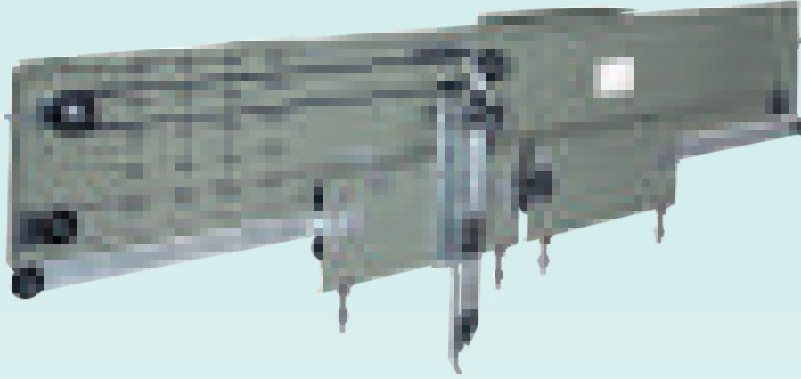

ДЕТАЛЬ-А  
МАСШТАБ 1:5

A: تفصیلات:

DETAY A  
ÖLÇEK 1:5

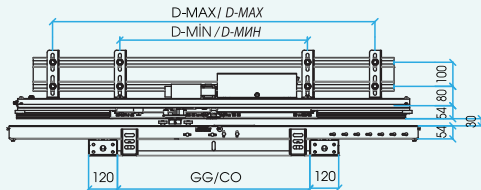

GİRİŞ GENİŞLİĞİ = GG  
CLEAR OPENING = CO  
ШИРИНА ВХОДА = GG  
GG: اتساع المدخل

|  | 600  | 700  | 800  | 900  | 1000 | 1100 | 1200 | 1300 |
|--|------|------|------|------|------|------|------|------|
| <b>A</b>                                 | 1250 | 1450 | 1650 | 1850 | 2050 | 2250 | 2450 | 2650 |
| <b>B</b>                                 | 320  | 370  | 420  | 470  | 520  | 570  | 620  | 670  |
| <b>C</b>                                 | 1250 | 1450 | 1650 | 1850 | 2050 | 2250 | 2450 | 2650 |
| <b>D-MIN / D-МИН</b><br>اصغري - D        | 540  | 620  | 780  | 840  | 900  | 960  | 1020 | 1100 |
| <b>D-MAX / D-МАХ</b><br>اعظمي - D        | 940  | 1140 | 1340 | 1540 | 1740 | 1940 | 2140 | 1730 |
| <b>AĞIRLIK / WEIGHT / МАССА</b><br>الوزن |      |      |      |      |      |      |      |      |

# 4 PANEL MERKEZİ KAT KAPISI

## 4 PANEL CENTRAL OPENING LANDING DOOR

### 4-ЕК ПАНЕЛЬНАЯ ДВЕРЬ ШАХТЫ

### باب خارجي 4 درف مركزي

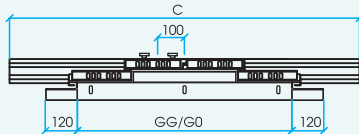
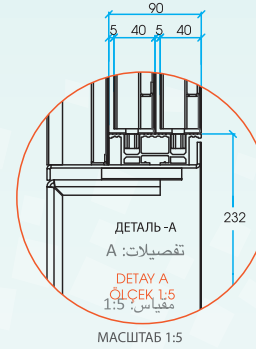
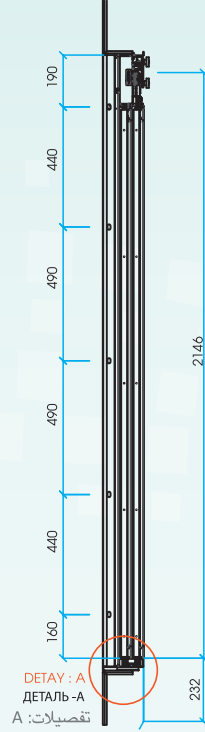
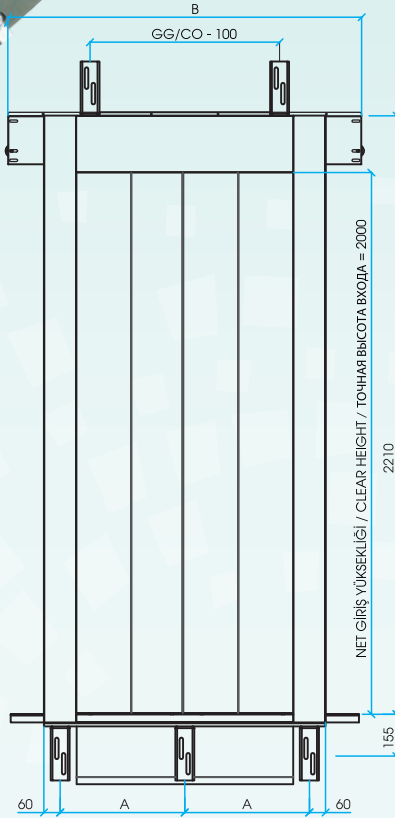
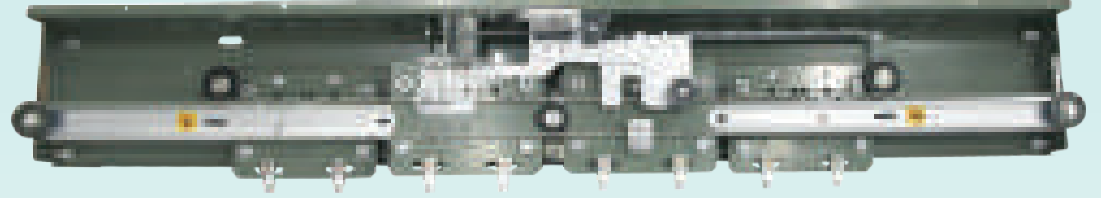
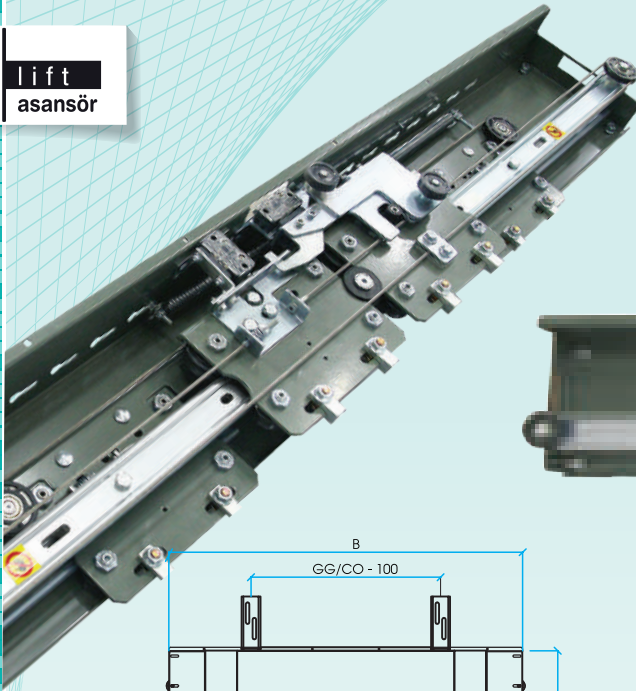

GİRİŞ GENİŞLİĞİ = GG  
CLEAR OPENING = CO  
ШИРИНА ВХОДА = GG  
اتساع المدخل

|          |      |      |      |      |      |      |      |
|----------|------|------|------|------|------|------|------|
|          | 700  | 800  | 900  | 1000 | 1100 | 1200 | 1300 |
| <b>A</b> | 410  | 460  | 510  | 560  | 610  | 660  | 710  |
| <b>B</b> | 1155 | 1305 | 1455 | 1605 | 1755 | 1905 | 2055 |
| <b>C</b> | 1155 | 1305 | 1455 | 1605 | 1755 | 1905 | 2055 |

# 4 PANEL MERKEZİ KABİN KAPISI (EN81-1)

4 PANEL CENTRAL OPENING CAR DOOR (EN81-1)

4-ЕХ ПАНЕЛЬНАЯ ЦЕНТРАЛЬНАЯ ДВЕРЬ КАБИНЫ (EN81-1)

باب داخلي 4 درف مركزي (EN81-1)

Kapılar Doors Двери الأبواب

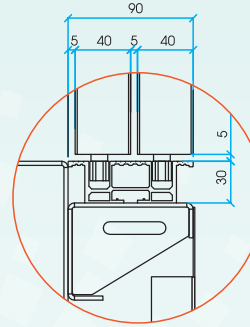
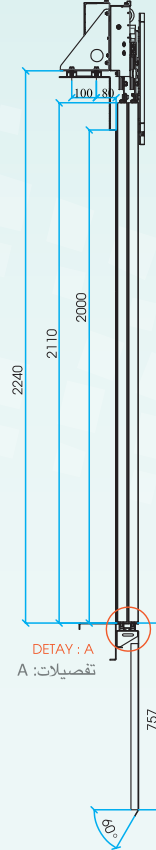
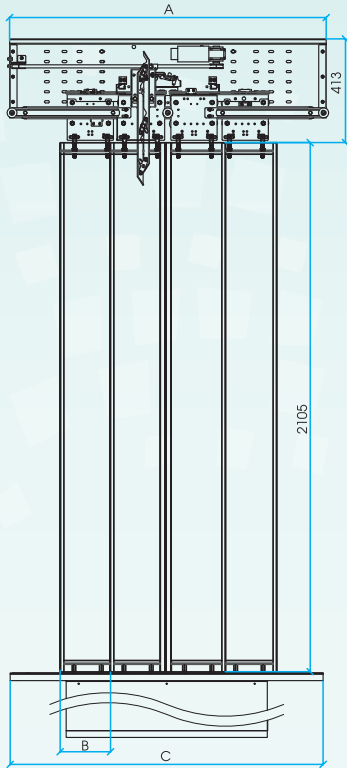
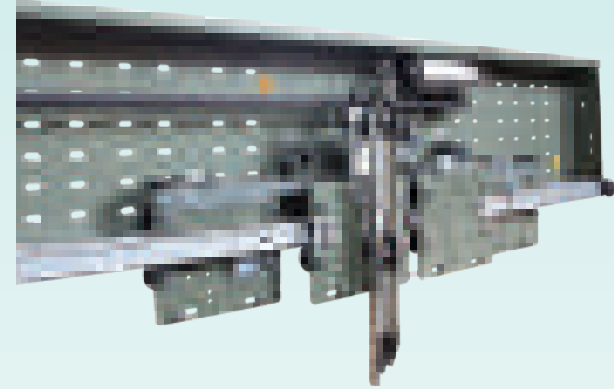
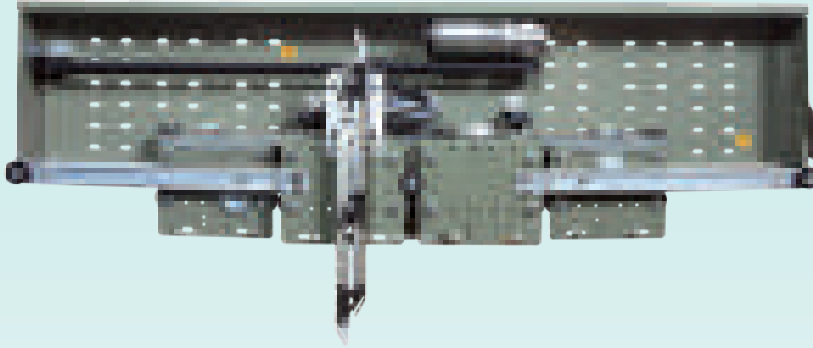

ДЕТАЛЬ-А  
МАСШТАБ 1:5

A: تفصیلات  
DETAY A  
ÖLÇEK 1:5

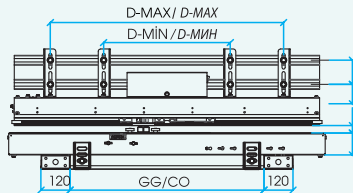

GİRİŞ GENİŞLİĞİ = GG  
CLEAR OPENING = CO  
ШИРИНА ВХОДА = GG  
اتساع المدخل = GG

|  | 700  | 800  | 900  | 1000 | 1100 | 1200 | 1300 |
|--|------|------|------|------|------|------|------|
| <b>A</b>                                 | 1110 | 1260 | 1410 | 1560 | 1710 | 1860 | 2010 |
| <b>B</b>                                 | 205  | 230  | 255  | 280  | 305  | 330  | 355  |
| <b>C</b>                                 | 1110 | 1260 | 1410 | 1560 | 1710 | 1860 | 2010 |
| <b>D-MIN / D-МИН</b><br>D-اصغري          | 520  | 520  | 520  | 660  | 660  | 660  | 800  |
| <b>D-MAX / D-МАХ</b><br>D-اعظمي          | 820  | 960  | 1100 | 1240 | 1380 | 1520 | 1660 |
| <b>AĞIRLIK / WEIGHT / МАССА</b><br>الوزن | 70   | 85   | 95   | 105  | 125  | 135  | 145  |

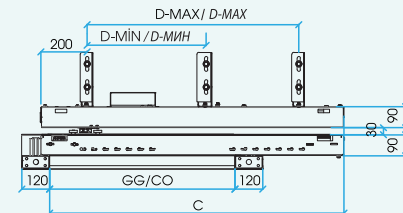
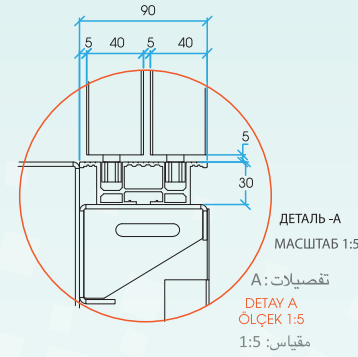
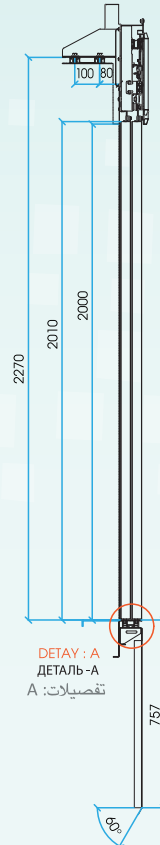
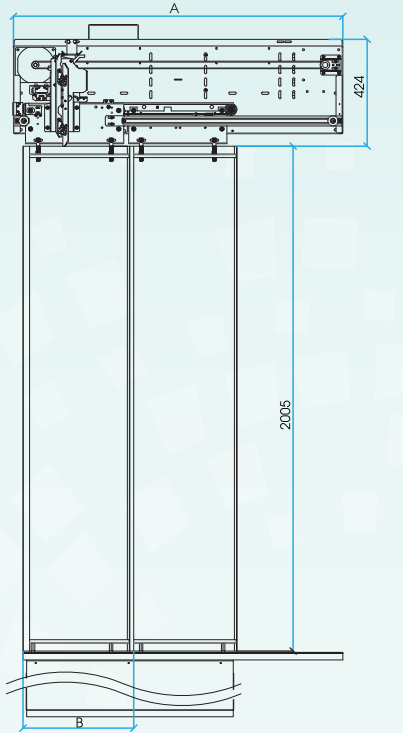
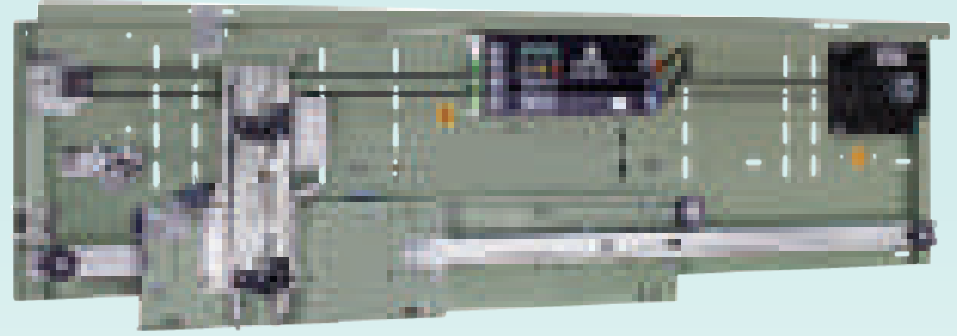

GİRİŞ GENİŞLİĞİ = GG  
CLEAR OPENING = CO  
ШИРИНА ВХОДА = GG  
GG: اتساع المدخل

|  | 600  | 700  | 800  | 900  | 1000 | 1100 | 1200 | 1300 |
|--|------|------|------|------|------|------|------|------|
| <b>A</b>                                 | 1005 | 1155 | 1305 | 1455 | 1605 | 1755 | 1905 | 2055 |
| <b>B</b>                                 | 340  | 390  | 440  | 490  | 540  | 590  | 640  | 690  |
| <b>C</b>                                 | 970  | 1120 | 1270 | 1420 | 1570 | 1720 | 1870 | 2020 |
| <b>D-MIN / D-МИН</b><br>D- اصغري         | 265  | 415  | 565  | 715  | 865  | 1015 | 1165 | 1315 |
| <b>D-MAX / D-МАХ</b><br>D- اعظمي         | 565  | 715  | 915  | 1065 | 1215 | 1365 | 1515 | 1665 |
| <b>AĞIRLIK / WEIGHT / МАССА</b><br>الوزن | 52   | 61   | 71   | 80   | 90   | 110  | 123  | 140  |

## 2 PANEL MERKEZİ KABİN KAPISI (EN81-20)

2 PANEL CENTRAL OPENING CAR DOOR (EN81-20)

2-УХ ПАНЕЛЬНАЯ ЦЕНТРАЛЬНАЯ ДВЕРЬ КАБИНЫ (EN81-20)

باب داخلي درفتين مركزي (EN81-20)

Kapılar Doors Двери الأبواب

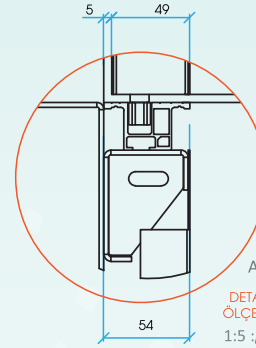
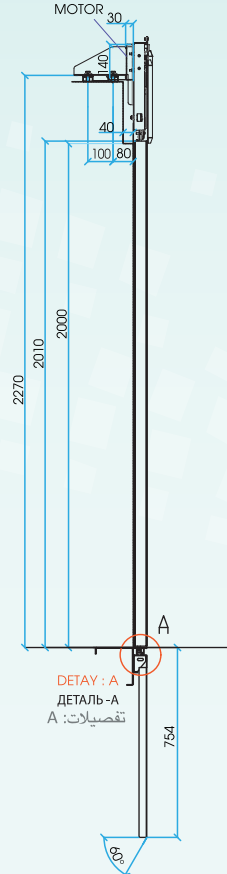
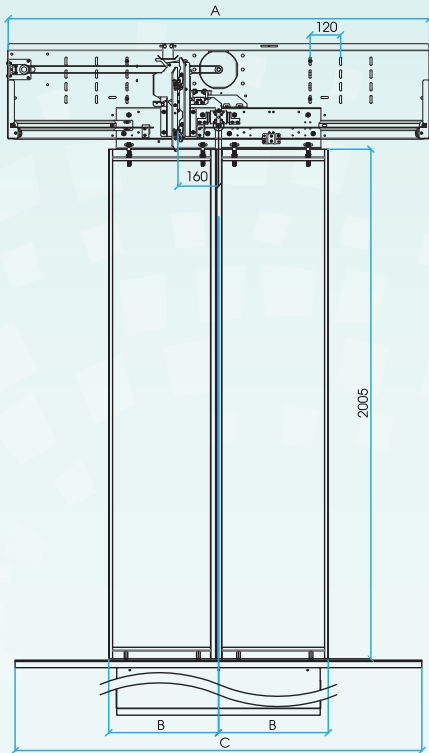
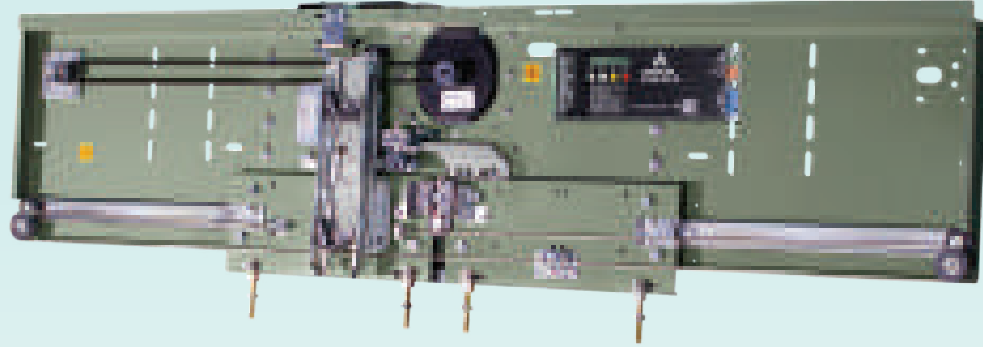

ДЕТАЛЬ-А  
МАСШТАБ 1:5

A : تقصیلات  
DETAY A  
ÖLÇEK 1:5  
مقیاس: 1:5

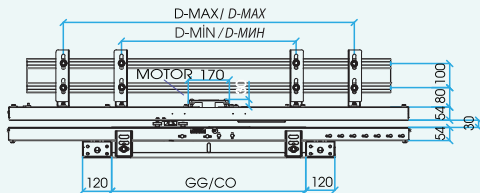

GİRİŞ GENİŞLİĞİ = GG  
CLEAR OPENING = CO  
ШИРИНА ВХОДА = GG  
اتساع المدخل = GG

|                                  | 600  | 700  | 800  | 900  | 1000 | 1100 | 1200 | 1300 |
|----------------------------------|------|------|------|------|------|------|------|------|
| <b>A</b>                         | 1260 | 1460 | 1660 | 1860 | 2060 | 2260 | 2460 | 2660 |
| <b>B</b>                         | 320  | 370  | 420  | 470  | 520  | 570  | 620  | 670  |
| <b>C</b>                         | 1240 | 1440 | 1640 | 1840 | 2040 | 2240 | 2440 | 2640 |
| <b>D-MIN / D-МИН</b><br>اصغري -D | 520  | 620  | 720  | 820  | 920  | 1020 | 1120 | 1220 |
| <b>D-MAX / D-МАХ</b><br>اعظمي -D | 800  | 1000 | 1200 | 1400 | 1600 | 1800 | 2140 | 2200 |



# ida lift

## asansör

### MRL

**EN** Best solution with high efficiency for public, hospital and office buildings. Flexible dimensions to fit every shaft, design according to European standards and safety rules, comfortable, noiseless working with long lifespan and suitable for high traffic. According to price-quality performance will be definitely your favorite choice.

**RU** Наиболее подходящее и эффективное решение для жилых домов, рабочих мест и больницы. Безопасен, соответствует стандартам, удобен, бесшумен, долговечен и устойчив к интенсивному движению, а благодаря своим гибким размерам совместим со всеми типами колодцев. Ваш абсолютный выбор благодаря своему соотношению цена-качество.

**AR** يقدم أفضل وانسب حل للمساكن واماكن العمل والمشافي. وهو يتميز بالامان وموافق للمقاييس ومريح وبدون صوت وذو عمر طويل ويتحمل الاستعمال الكثير واطرافه الى ذلك موافق لكل انواع اماكن المصاعد. نظرا لسعره وجودته فمن المؤكد انكم ستختارونه.

**TR** Konutlar, işyerleri ve hastaneler için en uygun ve verimli çözümü sunar. Emniyetli, standartlara uygun, konforlu, sessiz, uzun ömürlü ve yüksek trafikle dayanıklı olup esnek ölçüleri ile her türlü kuyuya uyumludur. Fiyat kalite performansı sayesinde mutlak tercihiniz olacaktır.

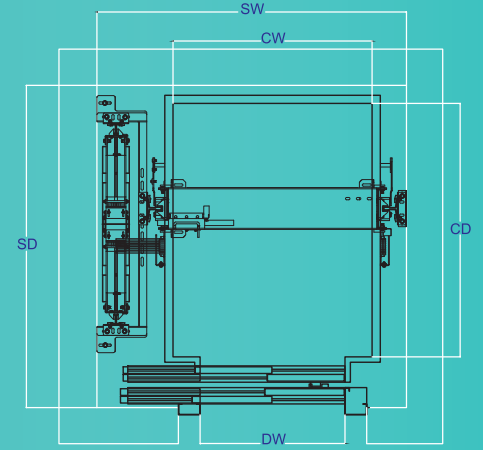
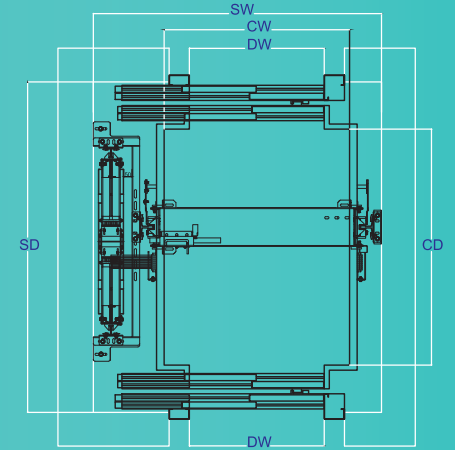

En Üst Kat Kesiti Last Floor Section Секция Верхнего Этажа نهاية على طابق

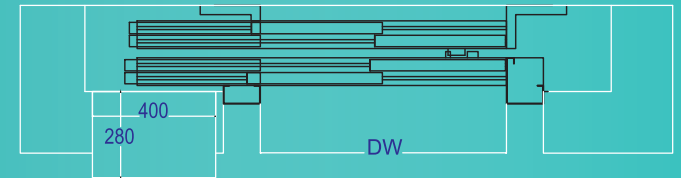

Kumanda Panosu Controller Панель Управления لوحة التحكم

#### Genel Özellikler / General Specifications / Общие Особенности / الخصائص العامة

|                                  |   |
|----------------------------------|---|
| Kapasite / capacity              | 320 - 1600 kg   |
| Грузоподъемность                 | 320 - 1600 кг   |
| Kişi / Person / Человек / السعة  | 4 - 21  |
| Hız / Speed / Скорость / الشخص   | 1.0 - 1.6 m/s 1,0- 1,6 м / с                                    |
| Max seyir / Max travel           | 50 m  |
| Макс. Высота подъема             | 50 м  |
| Durak / Stops                    | Standart 16 (opsiyonel / optional 21)                           |
| Остановка                        | Стандарт 16 (опция 21) (21 (حسب الطلب 21)                       |
| Giriş / Entrances                | Tek / 1 front (Opsiyonel karşılıklı çift / optional 2 opposite) |
| Вход                             | Один (Дополнительный двойной) (حسب الطلب مزدوج متقابل)          |
| Tahrik / Traction system         | Dişlisiz senkron VVVF makine / Gearless machine VVVF            |
| Привод                           | Без редукторный двигатель VVVF                                  |
| التحرك                           | ماكينة VVVF دون مستننات مدمجة                                   |
| Kumanda / Controller             | Arkel ARL300 + Adrive (optional ARL500 or Arcode)               |
| Пульт                            | Arkel ARL300 + Adrive (дополнительно ARL500 или Arcode)         |
| Kapılar                          | Otomatik sağ veya sol telescopic                                |
| Doors                            | Automatic side-opening 2 panel 700 - 1300 mm                    |
| Двери                            | Автоматические правые или левые телескопические 700-1300мм      |
| الابواب                          | له نظام تلسكوبي او توماتيكي لليمين او اليسار                    |
| Kapı yüks. / Door height         | Standart 2000 (Opsiyonel / Optional 2100 - 2200)                |
| Высота двери                     | Стандартная 2000 (дополнительно 2100- 2200)                     |
| ارتفاع الباب                     | متعارف 2000 (حسب الطلب 2100 - 2200)                             |
| Kabin ölçüleri / Car dimensions  | Proje bazında / Acc. to project                                 |
| Размеры Кабины                   | По Проекту / المشروع  |
| Kabin iç yüks. / Int. car height | 2150 / 2250   |
| الارتفاعات الداخلية للمقصورة     | 2150 / 2250   |

**Komple Asansör Sistemleri**  
Complete Elevator Systems  
Вся система Лифтов  
انظمة المصاعد المتكاملة

**Dişlisiz  
senkron makinalı  
makine dairesiz  
paket asansör**

*Machine roomless  
complete lift  
with gearless machine*

*Комплекс Лифта с  
безредуктивным синхронным  
двигателем для помещений  
без машинного отделения.*

**مصعد كامل ذو محرك  
مدمج دون مستنات  
ودون غرفة المحرك**

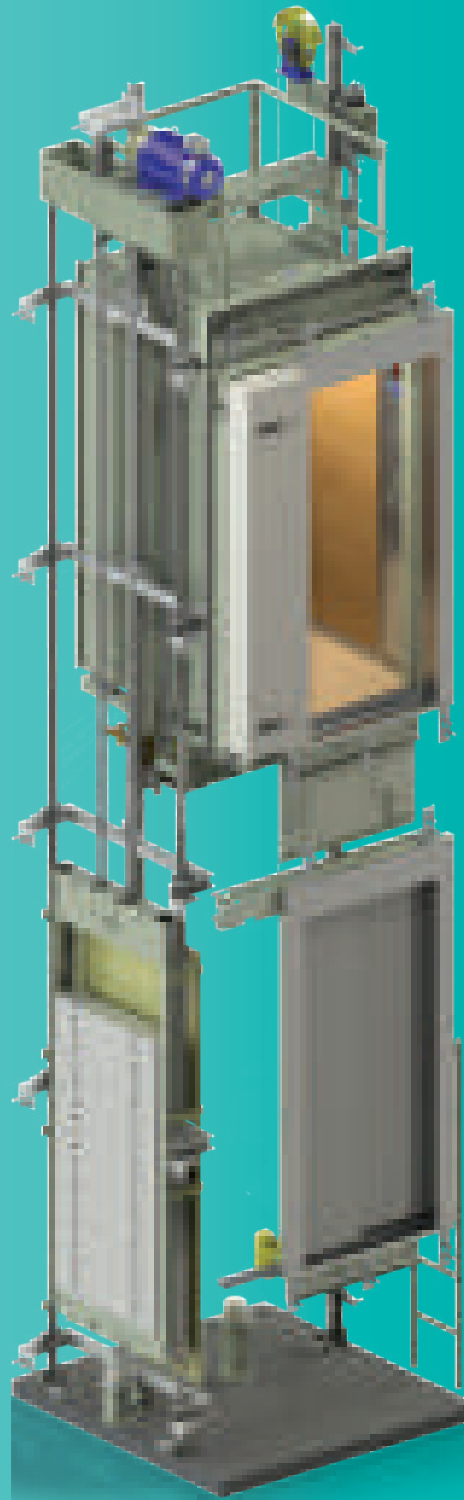
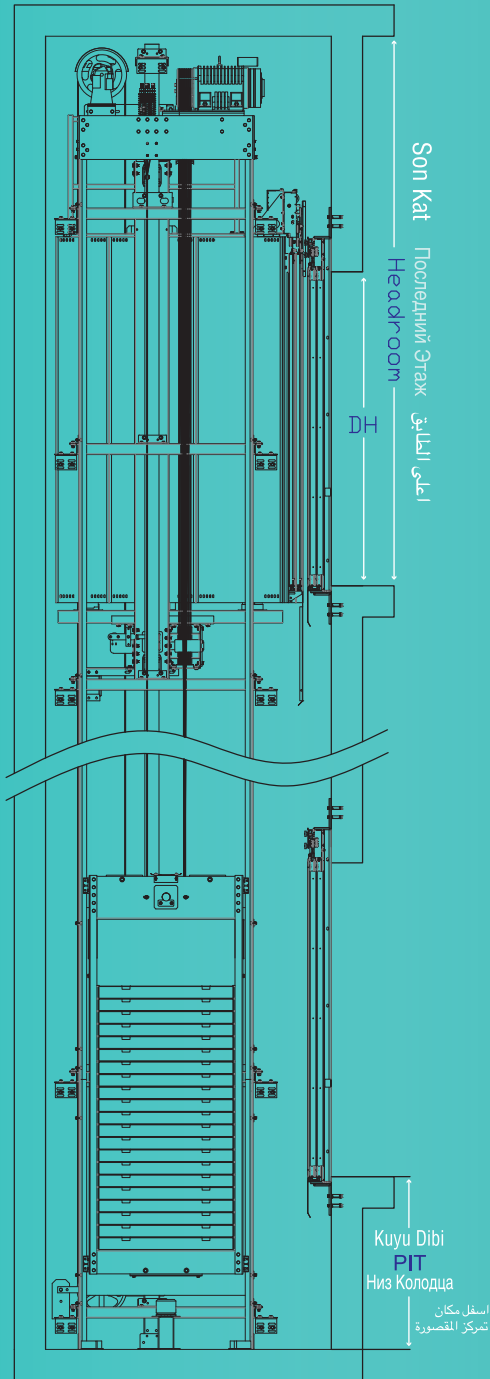

| Genel / General / Общее / جنرال    |  |   |   | Kabin / Cabin / Кабина / مقصورة              |   |  | Kapı / Door / Дверь / باب  |   | Kuyu / Shaft / Шахта / مكان تمرکز المصعد                             |  |  |   |   |  |
|------------------------------------|--|---|---|--|---|--|--|---|--|--|--|---|---|--|
| Hız<br>Speed<br>Скорость<br>السرعة | Yolcu<br>Persons<br>Пассажир<br>الركاب | Kapasite<br>Capacity<br>Грузоподъ<br>емность<br>السعة | Engelli Kullanımı<br>Disabled<br>Accessibility<br>Использование<br>для инвалидов<br>استعماله للمعاقين | Genişlik<br>Width<br>CW<br>Ширина<br>الامتاع | Derinlik<br>Depth<br>CD<br>Глубина<br>العمق | İç Yükseklik<br>Clear Height<br>CH<br>Внутренняя<br>Высота<br>الارتفاع الداخلي | Giriş<br>Entrance<br>DW<br>Вход<br>المدخل                            | Yükseklik<br>Height<br>DH<br>Высота<br>الارتفاع | Giriş Sayısı<br>Entrances<br>Количество Входов<br>عدد المدخل         | Ana Ray/Ağ. Rayı<br>Cabin/Cntrwight. Rails<br>Направляющие<br>рельсы/ Сеть Рельсов<br>السكة الرئيسية | Genişlik<br>Width<br>SW<br>Ширина<br>الامتاع | Derinlik<br>Depth<br>SD<br>Глубина<br>العمق | Kuyu Dibi<br>Pit<br>Дно Колодца<br>اسفل مكان<br>تمرکز المصورة | Son Kat<br>Headroom<br>Последний этаж<br>اعلى الطابق |
| 1 m/s                              | 4                                      | 320 kg  | ♿   | 900  | 1000  | 2150   | 700  | 2000  | 1<br>karşılıklı çift / opposite double entry<br>Двойная مزدوج متقابل | T70-T50  | 1500<br>(1470*)                              | 1380<br>XXX                                 | 1100 mm   | 3500 mm  |
|                                    | 6                                      | 450 kg  |   | 1000   | 1200  | 2150   | 800  | 2000  | 1<br>karşılıklı çift / opposite double entry<br>Двойная مزدوج متقابل |  | T70 - T50                                    | 1600<br>(1570*)                             |   |  |
|                                    | 8                                      | 630 kg  | ♿   | 1100   | 1400  | 2150   | 800  | 2000  | 1<br>karşılıklı çift / opposite double entry<br>Двойная مزدوج متقابل | T90 - T50  | 1700<br>(1680*)                              | 1780<br>1960                                |   |  |
|                                    | 10                                     | 800 kg  |   | 1350   | 1400  | 2150   | 900  | 2000  | 1<br>karşılıklı çift / opposite double entry<br>Двойная مزدوج متقابل |  | T90 - T70                                    | 2000<br>(1970*)                             |   |  |
|                                    | 13                                     | 1000 kg   |   | 1400   | 1600  | 2150   | 900  | 2000  | 1<br>karşılıklı çift / opposite double entry<br>Двойная مزدوج متقابل | T90 - T70  | 2050<br>(2020*)                              | 1980<br>2160                                |   |  |
|                                    |  |   |   | 1100   | 2100  | 2150   | 900  | 2000  | 1<br>karşılıklı çift / opposite double entry<br>Двойная مزدوج متقابل |  | T90 - T70                                    | 1740<br>(1710*)                             |   |  |
|                                    | 16                                     | 1250 kg   |   | 1200   | 2300  | 2250   | 1100   | 2100  | 1<br>karşılıklı çift / opposite double entry<br>Двойная مزدوج متقابل | T125 - T70   | 2000   | 2680<br>2860                                |   |  |
| 21                                 | 1600 kg                                | 1400  | 2400  | 2250   | 1300  | 2100   | 1<br>karşılıklı çift / opposite double entry<br>Двойная مزدوج متقابل | T125 - T90                                      | 2300   |  | 2780<br>2960                                 |   |   |  |
| 1.6 m/s                            | 4                                      | 320 kg  | ♿   | 900  | 1000  | 2150   | 700  | 2000  | 1<br>karşılıklı çift / opposite double entry<br>Двойная مزدوج متقابل | T70 - T50  | 1500<br>(1470*)                              | 1380<br>XXX                                 | 1300 mm   | 3700 mm  |
|                                    | 6                                      | 450 kg  |   | 1000   | 1200  | 2150   | 800  | 2000  | 1<br>karşılıklı çift / opposite double entry<br>Двойная مزدوج متقابل |  | T70 - T50                                    | 1600<br>(1570*)                             |   |  |
|                                    | 8                                      | 630 kg  | ♿   | 1100   | 1400  | 2150   | 800  | 2000  | 1<br>karşılıklı çift / opposite double entry<br>Двойная مزدوج متقابل | T90 - T50  | 1700<br>(1680*)                              | 1780<br>1960                                |   |  |
|                                    | 10                                     | 800 kg  |   | 1350   | 1400  | 2150   | 900  | 2000  | 1<br>karşılıklı çift / opposite double entry<br>Двойная مزدوج متقابل |  | T90 - T70                                    | 2000<br>(1970*)                             |   |  |
|                                    | 13                                     | 1000 kg   |   | 1600   | 1400  | 2150   | 900  | 2000  | 1<br>karşılıklı çift / opposite double entry<br>Двойная مزدوج متقابل | T90 - T70  | 2050<br>(2020*)                              | 1980<br>2160                                |   |  |
|                                    |  |   |   | 1100   | 2100  | 2150   | 900  | 2000  | 1<br>karşılıklı çift / opposite double entry<br>Двойная مزدوج متقابل |  | T90 - T70                                    | 1740<br>(1710*)                             |   |  |
|                                    | 16                                     | 1250 kg   |   | 1200   | 2300  | 2250   | 1100   | 2100  | 1<br>karşılıklı çift / opposite double entry<br>Двойная مزدوج متقابل | T125 - T70   | 2000   | 2680<br>2860                                |   |  |
| 21                                 | 1600 kg                                | 1400  | 2400  | 2250   | 1300  | 2100   | 1<br>karşılıklı çift / opposite double entry<br>Двойная مزدوج متقابل | T125 - T90                                      | 2300   |  | 2780<br>2960                                 |   |   |  |

\* Direk paslanmaz KBN10 modeli ile

\*\* Kuyu ölçüleri 2 panel teleskopik kapiya göre.

\*\*\* Kumanda panosu dolabı son katta kapı yanında yerleştirilmektedir.

\* Only with cabin model KBN 10

\*\* Shaft dimensions are according to 2 panels doors

\*\*\* Controller installed in last floor, next to door frame.

\* С прямым нержавеющей типом KBN10

\*\* Размеры колодца указаны для 2-х ствольной телескопической двери.

\*\*\* Шкаф пульта управления находится рядом с дверью на последнем этаже.

\* عمود لا يصدأ بموديل KBN10

\*\* قياسات مكان تمرکز المصورة حسب باب ذي لوحتين تليسكوبيتين

\*\*\* تم وضع خزانة لوحة التحكم في الطابق الاخير جانب الباب

## TR Genel

Kompak tasarım, sessiz ve konforlu hareket, yüksek verimli dişlisiz senkron makina. Opsiyonel, özel sertifikalı kayışlı sistem seçeneği.

### Kapılar

Yoğun trafîğe uygun, sessiz çalışan ve değişik kaplama seçenekleri sunan yüksek kaliteli İdadoor kapılar.

### Otomatik kurtarma sistemi

Kumanda panosuna bağlı olan UPS yardımı ile acil durumda ve elektrik kesintisinde kata getirme sistemi standart sunulmaktadır.

### Esnek ölçü

Esnek kuyu, kabin ve kapı ölçüleri sayesinde her tür projeye uygulanabilirliği şansı. Opsiyonel olarak kapı kasası içine kumanda tablosunu yerleştirebilme imkanı.

## EN General

Compact design, quiet and comfortable travel, gearless energy efficient permanent magnet machine. Optional, special certified belt system required.

### Doors

Reliable and noiseless, high quality İdadoor automatic doors which are specially constructed for high traffic

### Automatic rescue system

Standart fully automated evacuation system can evacuate passengers in the event of power failure.

### Flexible dimensions

Fit to every project due to flexible shaft, car and door configurations. Optional controller inside door frame required.

## RU Общие

Сведения Компактный дизайн, бесшумное и удобное движение, высокоэффективная безредукторная синхронная машина. Дополнительный, специально сертифицированный вариант ременной системы.

### Двери

Высококачественные двери İdadoor, которые подходят для интенсивного движения, работают бесшумно и предлагают различные варианты покрытия.

### Система автоматического спасения

С помощью UPS, подключенного к панели управления, в стандартной комплектации предусмотрена система опускания на этаж в случае аварии и сбоя питания.

### Гибкий Размер

Возможность применения для любых проектов благодаря гибким размерам колодца, кабины и двери. Опционально возможность размещения панели управления внутри дверной коробки.

**Komple Asansör Sistemleri**  
**Complete Elevator Systems**  
Вся система Лифтов  
انظمة المصاعد المتكاملة

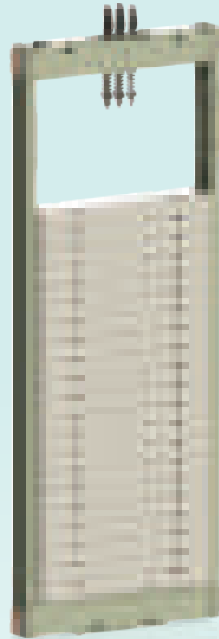
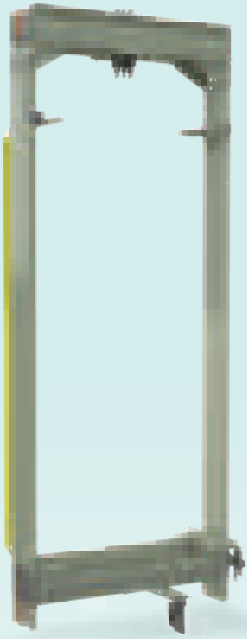

**1:1 Askı Karkaslar**  
**1:1 Acting Car Frames**  
Каркас с подвеской 1:1  
إطارات نظام التعليق 1:1

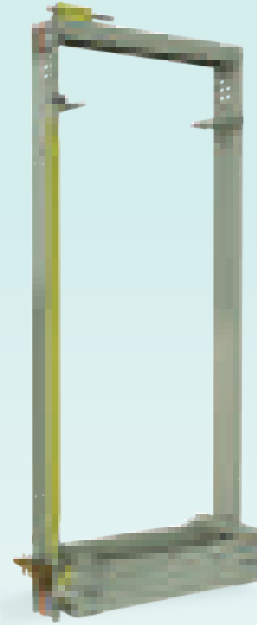

**2:1 Askı Karkaslar**  
**2:1 Acting Car Frames**  
Каркас с подвеской 2:1  
إطارات نظام التعليق 1:2

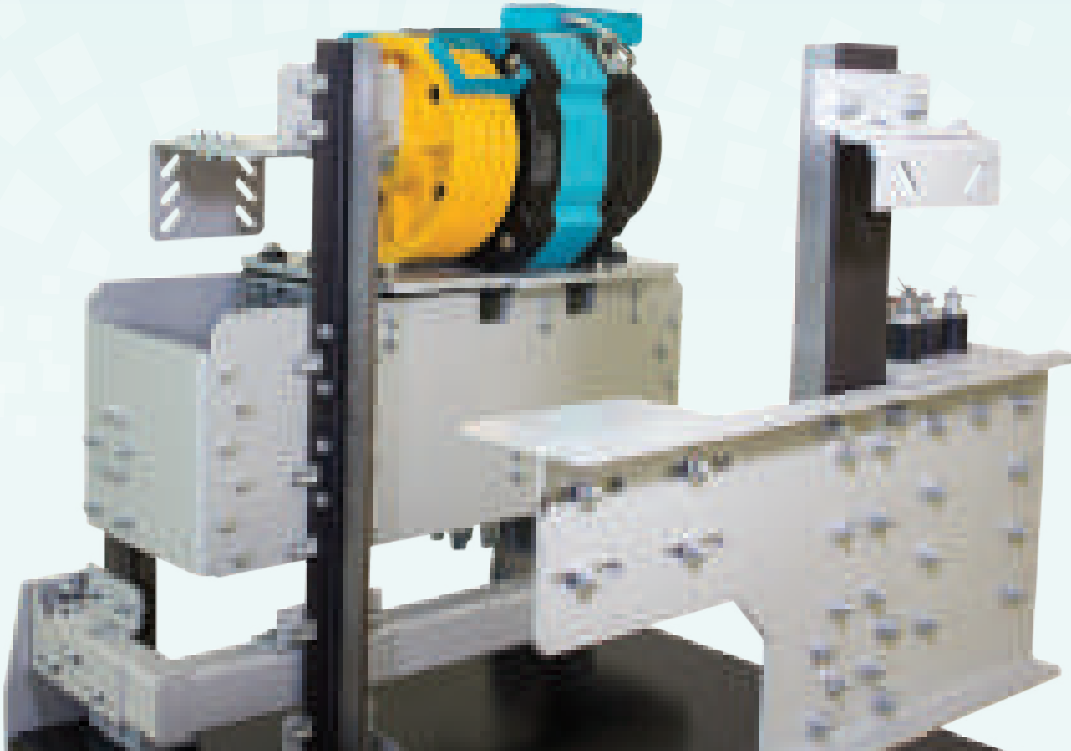

**بشكل عام** AR

انه محرك متسارع دون مسننات له تصميم الكومباك ودون صوت وحركته مريحة ذات انتاجية عالية وله شهادة خاصة به وله قابلية اختيار حزام.

**الابواب**

ابواب إيدا دور (İDADOOR)؛ مناسب في حالات الازدحام ويعمل دون صوت وله انواع مختلفة من شكلها الخارجي ونوعية عالية.

**نظام الانقاذ الأوتوماتيكي**

انه نظام تم تصميمه حسب المواصفات القياسية بحيث مربوطا بلوحة التحكم بمساعدة UPS حيث يعمل في حالة الطوارئ وحالة انقطاع التيار الكهربائي للمساعدة في الوصول لأقرب طابق.

**قياسات مرنة**

نظرا لمرونة قياسات الابواب والمقصورة فهو مناسب لكل المشاريع كما انه يمكن وضع لوحة تحكم على اطار الباب حسب الطلب

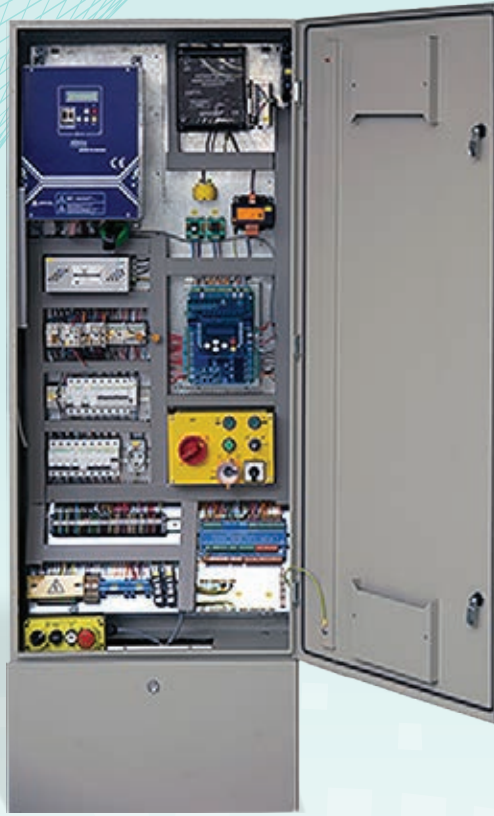

## ARL 700 Pano

TR EN

|  |   |
|--|---|
| Uyumlu Olduğu Standartlar<br>Compliance to Standards | En 81/1-2/20+A3<br>En 81/1-2/20+A3  |
| Durak Sayısı<br>Number of Stops                      | 64 Durak<br>64 Stops  |
| Kumanda Tipi<br>Control Type                         | Tek Buton Toplama Çift, Buton Toplama<br>Single Button Pickup, Double Button Pickup                                   |
| Tahrik Tipi<br>Drive Type                            | Hidrolik - VVVF<br>Hydraulic VVVF   |
| Asansör Hızı<br>Elevator Speed                       | 2,5 m/s hıza kadar<br>25 m/s Up to 4 m/s  |
| Grup Kumanda<br>Group Control                        | 8 Asansöre Kadar<br>Up to 8 Elevators   |
| Seri Haberleşme<br>Serial Communication              | Kat ve kabin ile<br>With Floor and Cabin  |
| Kabin Pozisyon Bilgisi<br>Cabin Position Information | Manyetik şalterler, Enkoderli sistem<br>Magnetic Switches, Encoder System   |
| Otomatik Kapı Kontrolü<br>Automatic Door Control     | Tek Kapı, Çift Kapı<br>Single Door, Double Door   |
| Kapı Köprüleme<br>Door Bridging                      | Var<br>Available  |
| Gösterge Çıktıları<br>Display Outputs                | 7 segment, Gray/Binary kod, LCD çıkış<br>7 Segments, Gray/Binary Code, LCD Output                                     |
| Menü Dilleri<br>Language Options                     | Türkçe, İngilizce (Arem ile ek dil seçeneği)<br>Turkish, English (Additional language option with Arem Hand Terminal) |

## ПАНЕЛЬ ARL 700

RU

|                                  |   |
|----------------------------------|---|
| Соответствие Стандартам          | En 81/1-2/20+A3   |
| Количество Остановок             | 64 Остановки N  |
| Тип Управления                   | Сбор С Одной Кнопкой, Сбор С Двойной Кнопкой                |
| Тип Привода                      | Гидравлический - VVVF                                       |
| Скорость Лифта                   | до 2,5 м/с  |
| Групповое Управление             | До 8 Лифтов   |
| Последовательная Связь           | С Этажем и Кабиной  |
| Информация о Положении Кабины    | Магнитные Переключатели, Система Кодирования                |
| Автоматическое Управление Дверью | Ододверная, Двойная Дверь                                   |
| Дверной мост                     | Нет   |
| Индикатор                        | Выходы 7 Сегментов, GrayЯзыки меню                          |
| Языки меню                       | Турецкий, английский (дополнительные языковые опции с Arem) |

## ARL 700 لوحة

AR

|   |                            |
|---|----------------------------|
| En 81/1-2/20+A3   | القياسات المتوافقة         |
| 64 موقف   | عدد المواقف                |
| مزودج مجمعة على مفتاح واحد، مفاتيح مجمعة                      | نوع التحكم                 |
| هيدروليك - VVVF   | نوع التحرك                 |
| يتحرك بسرعة 2.5 م/ثا  | سرعة المصعد                |
| يتم التحكم حتى 8 مصاعد  | التحكم المجمع              |
| بالتابع وبالمقصورة  | الاتصال السريع             |
| مفاتيح المغناطيسية، نظام التشفير                              | معرفة مكان المقصورة        |
| باب واحد، باب مزدوج   | التحكم الاوتوماتيكي للباب  |
| يوجد  | تعبير مستوى الباب          |
| 7 اصناف، غراي بيناري كود، LCD مخرج                            | المخارج الكهربائية المرئية |
| التركيبة الانجليزية (ويمكن اضافة لغة اخرى بواسطة ارام (AREM)) | قائمة اللغات               |



# ARCODE Pano / ПАНЕЛЬ ARCODE

TR EN RU

|   |   |
|---|---|
| Uyumlu Olduğu Standartlar<br>Compliance to Standards<br>Соответствие Стандартам       | En 81/1-2/20+A3<br>En 81/1-2/20+A3<br>En 81 / 1-2 / 20 + A3   |
| Durak Sayısı<br>Number of Stops<br>Количество Остановок                               | 64 Durak<br>64 Stops<br>64 Остановки  |
| Kumanda Tipi<br>Control Type<br>Тип Управления  | Tek Buton Toplama Çift, Buton Toplama<br>Single Button Pickup Double Button Pickup<br>Сбор С Одной Кнопкой, Сбор С Двойной Кнопкой  |
| Tahrik Tipi<br>Drive Type<br>Тип Привода  | Kademesiz Hızlı Dişlili, Makine Dişlisiz Makine, (Makine Daireli veya MRL)<br>Stepless Quick Gear (Machine Gearless Machine (Machine with Ring or MRL)<br>Бесступенчатый Редуктор, Машинный Безредукторный Механизм (Машинное Отделение Или MRL)  |
| Asansör Hızı<br>Elevator Speed<br>Скорость Лифта                                      | 4 m/s hız kadar<br>Up to 4 m/s<br>до 4 м / с  |
| Grup Kumanda<br>Group Control<br>Групповое Управление                                 | 8 Asansöre Kadar<br>Up to 8 Elevators<br>до 8 Лифтов  |
| Seri Haberleşme<br>Serial Communication<br>Последовательная Связь                     | Kat ve kabin ile<br>With Floor and Cabin<br>С Этажем и Кабиной  |
| Kabin Pozisyon Bilgisi<br>Cabin Position Information<br>Информация о Положении Кабины | Manyetik şalterler, Enkoderli sistem<br>Magnetic Switches, Encoder System<br>Магнитные Переключатели, Система Кодирования   |
| Otomatik Kapı Kontrolü<br>Automatic Door Control<br>Автоматическое Управление Дверью  | Tek Kapı, Çift Kapı<br>Single Door, Double Door<br>Ододверная, Двойная Дверь  |
| Kapı Köprüleme<br>Door Bridging<br>Дверной мост                                       | Yok<br>Not Available<br>Нет   |
| Gösterge Çıktıları<br>Display Outputs<br>Индикатор                                    | 7 segment, Gray/Binary kod, LCD çıkış<br>7 Segments, Gray/Binary Code, LCD Output<br>Выходы 7 Сегментов, Gray   |
| Menü Dilleri<br>Language Options<br>Языки меню  | Türkçe, İngilizce, Rusça, Fransızca, Flemence, İspanyolca, İsveççe, Lehçe, Almanca, Slovakça<br>Turkish, English, Russian, French, Dutch, Spanish, Swedish, Polish, German, Slovak<br>Турецкий, Английский, Русский, Французский, Голландский, Испанский, Шведский, Польский, Немецкий, Словацкий |

## Kumando Panoları Controllers Панели управления لوحات التحكم



AR

## ARCODE لوحة

|  |                            |
|--|----------------------------|
| En 81/1-2/20+A3  | القياسات المتوافقة         |
| 64 موقف  | عدد المواقف                |
| مزدوج مجموعة على مفتاح واحد، مفاتيح مجموعة   | نوع التحكم                 |
| محرك ذات مسننات سريعة دون تدرج، محرك دون مسننات، (ذو غرفة محرك اوMRL)                                    | نوع التحرك                 |
| يتحرك بسرعة 4 م/ثا   | سرعة المصعد                |
| يتم التحكم حتى 8 مصاعد   | التحكم المجمع              |
| بالتابع وبالمقصورة   | الاتصال السريع             |
| مفاتيح المغناطيسية، نظام التشفير   | معرفة مكان المقصورة        |
| باب واحد، باب مزدوج  | التحكم الاوتوماتيكي للباب  |
| لا يوجد  | تعديل مستوى الباب          |
| LCD مخرج   | المخارج الكهربائية المرئية |
| التركية، الانجليزية، الروسية، الفرنسية، الفلمنجية، الاسبانية، السويدية، البولندية، الالمانية، السلوفينية | قائمة اللغات               |



AV41B2



AV41B0

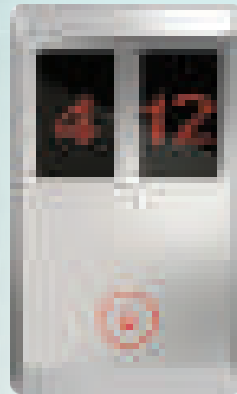

AV1022



AV1082



AV1002



AV2002



1012

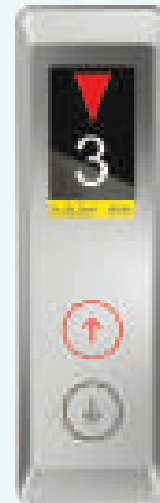

20B2

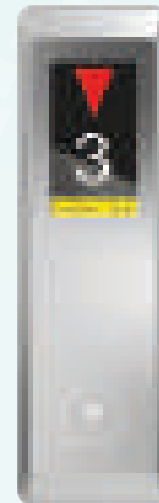

10B2



AV1072

**Kat ve Kabin Butonyerleri**  
**Landing and Cabin Panels**  
Панели управления Кабин и Этажей  
مفاتيح التشغيل الداخلية والخارجية



AVOX AV7

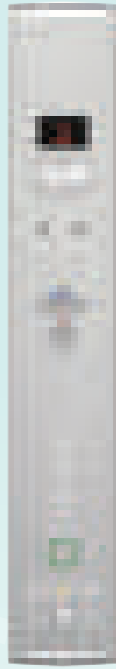

AV7 - CANBUS - CDD

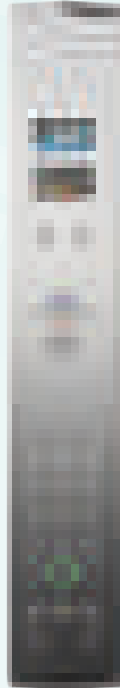
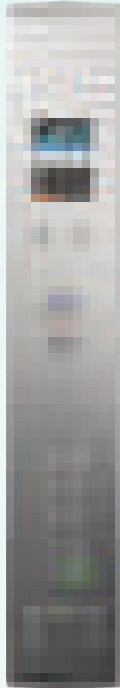
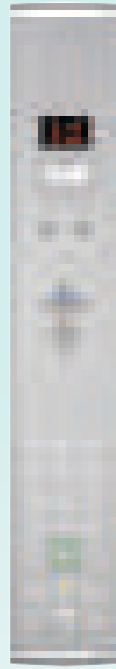
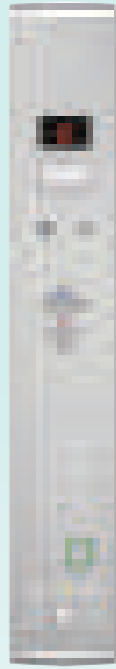

AV7 - CANBUS - CT4 - V102

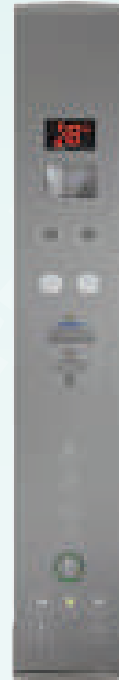

AV7 Redline



## ASANSÖR MOTOR ÇEŞİTLERİ ASANSÖRLER İÇİN DİŞLİSİZ MOTORLAR

### LIFT RANGE

GEARLESS MACHINES FOR ELEVATORS

1:1 - 2:1 - 4:1

Askı/Roping 320-3000 Kg.

Hız/Speed: 0.25 m/sn - 3.00 m/sn

1:1 - 2:1 - 4:1

Подвеска: 320-3000 кг.

Скорость: 0,25 м / с - 3,00 м / с

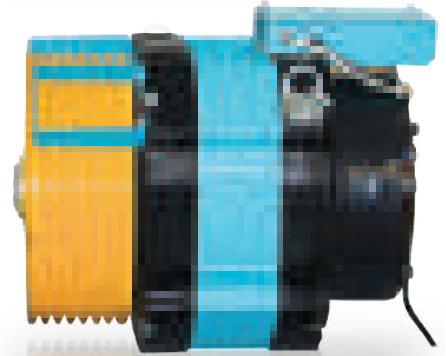
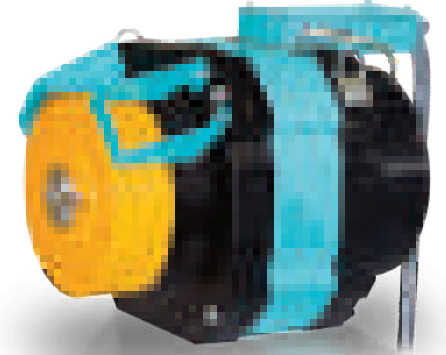

4:1 - 2:1 - 1:1

قوة الشد: 3000-320 Kg

السرعة: 0.25 m/sn - 3.00 m/sn





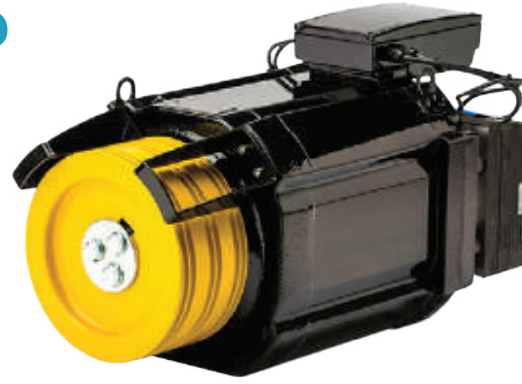

РАЗНОВИДНОСТИ  
ДВИГАТЕЛЕЙ ДЛЯ ЛИФТОВ  
ДВИГАТЕЛИ БЕЗ РЕДУКТОРА ДЛЯ ЛИФТА

أنواع محركات المصاعد  
محركات دون مستنات للمصاعد

1:1 - 2:1 - 4:1  
Ask/Roping 320-3000 Kg.  
Hız/Speed: 0.25 m/sn - 3.00 m/sn



1:1 - 2:1 - 4:1  
Подвеска: 320-3000 кг.  
Скорость: 0.25 м / с - 3.00 м / с



4:1 - 2:1 - 1:1  
قوة الشد: 3000-320 Kg.  
Hız: 0.25 m/sn - 3.00 m/sn: السرعة





TR

#### STANDART ÖZELLİKLER

- 2:1 askıda 240 kg'dan 1600 kg'a kadar; 1:1 askıda 320 kg'dan 800 kg'a kadar 140'tan 850 Nm sürme torkuna sahip motorlarımız listelenmiştir.
- Motor koruma sınıfı IP44
- TENV uygulaması
- İzolasyon sınıfı F
- Kutuplar: M/T24 S/.../L = 24 kutup serisi - T32 S/.../L/XL = 30 kutup serisi
- Bütün motorlarda sarğı termal koruma mevcuttur. (3x PTC)
- Motor sınıfı S3 % 40
- UNI EN81-1:2010 standardına göre imal edilmiş ve TÜV SÜD tarafından belgelendirilmiştir.
- Farklı güçler için tek faz ve üç faz motor temini.
- 0,5 m/s'den 3 m/s'ya kadar olan hızlar için tasarlanmış sarğılar
- Gerek sertleştirilmiş çelik (HRC≥50) ve sfero demir döküm LC tahrik kasnakları, müşterinin şartnamesine göre işlenecektir.
- IP64 mutlak ve arımlı kodlayıcılar, IP64'teki (Endat-sincos-SSI), daima tüm motor ebatları içerisinde olup hasarlara karşı bir koruma kapağı vardır.
- Kodlayıcılar, konektörsüz 10 metre uzunluğunda dışa giden kablolarla birlikte temin edilir.
- Motorlar, dışa giden kablolar olmaksızın terminal tablosuyla birlikte temin edilir.

#### UYGULAMA ALANLARI

- Makine dairesiz asansörler (M.R.L)
- Makine dairesiz asansörler (modernizasyon)
- Kaldıraçlar / Vinçler
- Ev asansörleri

#### مجالات التطبيق

- مصاعد دون غرفة المحرك (M.R.L)
- مصاعد لها غرفة المحرك (محدث)
- الرافعات
- المصاعد المنزلية أنواع

EN

#### STANDARD FEATURES

- Full range and properly intercalated within the driving torque range 140 to 850 Nm for payload 240 to 1.600 kg in roping 2:1 and 320 to 800 kg in roping 1:1 motors are listed.
- Motor protection class: IP44
- TENV implementation
- Insulation class F
- Poles: series M/T24 S/.../L = 24 poles - series T32 S/.../L/XL = 30 poles
- Winding thermal protection is always existing in all motors. (3xPTC)
- Motor class: S3 40%
- In accordance with UNI EN81-1:2010 certified by TÜV SÜD
- Single-phase and three-phase drive for different power supply
- Windings designed for speeds from 0,5 m/s to 3 m/s
- Traction sheaves LC in both hardened steel (HRC≥50) and spheroidal cast iron to be machined according to customer specification
- IP64 absolute and incremental encoders (Endat-sincos-SSI) in IP64, always inside the motor overall dimensions and with a protection cover against damages
- Encoders supplied with 10 m-long outgoing cable without connector
- Motors supplied with terminal board without outgoing cables

#### TARGET APPLICATIONS

- Elevators without machine room (M.R.L)
- Elevators with machine room (modernization)
- Elevators/hoists
- Home lifts

RU

#### СТАНДАРТНЫЕ ФУНКЦИИ

- На подвеске 2:1 от 240 кг до 1600 кг; 1:1 На подвеске от 320 кг до 800 кг от 140 до 850 Нм с приводным крутящим моментом - наши двигатели
- Класс защиты двигателя IP44
- TENV применение
- Класс изоляции F
- Полюса: M / T24 S /.../ L = 24-полюсная серия - T32 S /.../ L / XL = 30-полюсная серия
- Все двигатели имеют тепловую защиту обмоток. (3x PTC)
- Класс двигателя S3 40%
- Он изготовлен в соответствии со стандартом UNI EN81-1: 2010 и сертифицирован TÜV SÜD.
- Однофазное и трехфазное питание двигателей различной мощности.
- Обмотки рассчитаны на скорость от 0,5 м /с до 3 м /с
- Ведущие шкивы из закаленной стали (HRC≥50) и чугуна с шаровидным графитом LC обрабатываются в соответствии со спецификациями заказчика.
- Абсолютные и инкрементальные энкодеры IP64 и IP64 (Endat-sincos-SSI) всегда подходят для двигателей любого размера и имеют защитную крышку от повреждений.
- Энкодеры поставляются с отходящими кабелями длиной 10 метров без разъема.
- Двигатели поставляются с клемной колодкой без отходящих кабелей.

#### СФЕРА ПРИМЕНЕНИЯ

- Лифты без машинного помещения (M.R.L)
- Лифты с машинным отделением (modernization)
- Подъемники /Краны
- Домашние лифты

AR

#### المواصفات القياسية

- تم عرض محركات ذات قوة الشد 2:1 من 240 كغ حتى 1600 كغ؛ في قوة الشد 1:1 من 320 كغ حتى 800 كغ # من 140 حتى 850 Nm سحب عزم الدوران
- نوع حماية المحرك IP44
- تطبيق TENV
- نوع العزل F
- الاقطاب: تتسلسل القطب M/T24 S/.../L = 24 تتسلسل القطب M/T24 S/.../L/XL = 30
- تم لف كل المحركات بملفات حرارية (3x PTC)
- نوع المحرك 40 % 53

- تم تصنيعه حسب المواصفات القياسية UNI EN81-1:2010 وتم توثيقه من قبل TÜV SÜD
- تأمين محرك ذو خط فاز واحد و3 فازات لذات قوات مختلفة
- ملفات مصممة من أجل سرعات تتراوح بين 0,5 m/s و 3 m/s
- فولاد مقسى (HRC≥50) وصب حديد الدكتايل تتحرك ببيكرات LC سيتم تصنيعها حسب طلب الزبون.
- مشغرات IP64 ثابتة وعند الحاجة متزايدة، المحركات (Endat-sincos-SSI) في IP64 وهذه ايببات موجودة دائماً # في كل المحركات وله غلاف حماية ضد الصدمات.
- يمكن تأمين المشغرات مع الكابلات التي تنهب للخارج بطول 10 امتار بدون توصيلات
- يمكن تأمين المحركات مع لوحة حرارية بدون الكابلات التي تنهب للخارج

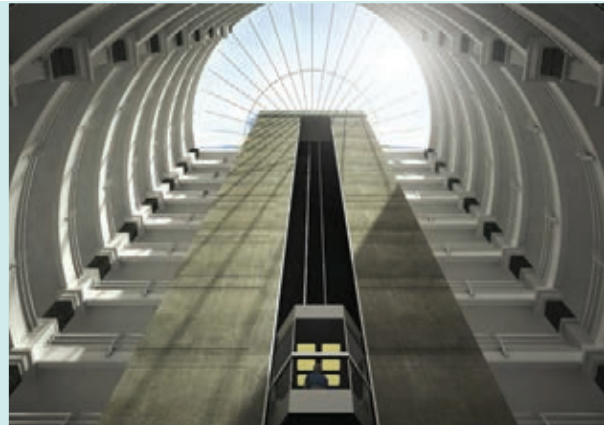

RATED TORQUE UP TO 250 Nm - MAX PAYLOAD 630  
RATED TORQUE UP TO 250 Nm - MAX PAYLOAD 630

RATED TORQUE UP TO 850 Nm - MAX PAYLOAD 1600 kg  
RATED TORQUE UP TO 850 Nm - MAX PAYLOAD 1600 кг

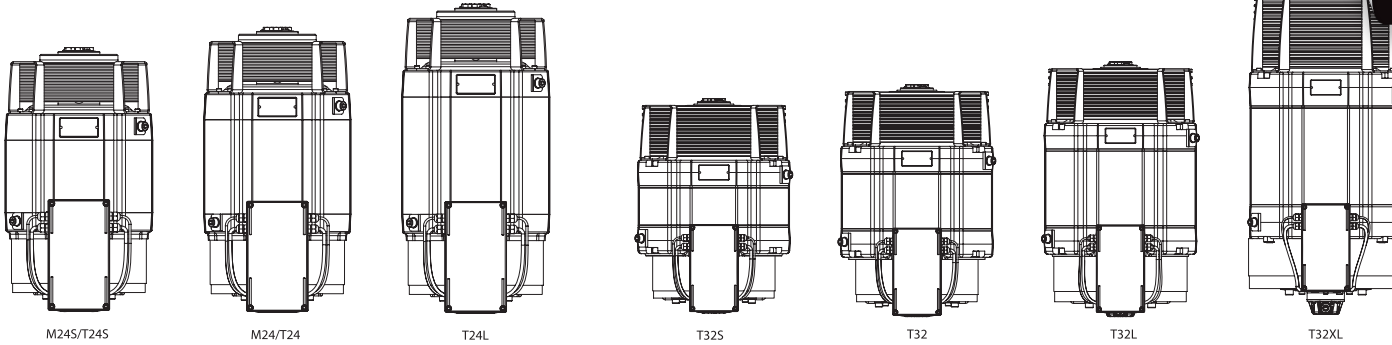

MOTOR ÖZELLİKLERİ MOTOR SPECIFICATIONS ХАРАКТЕРИСТИКА ДВИГАТЕЛЯ

خصائص المحرك

| Motor size                  | حجم المحرك | M24S/T24S                                      | M24/T24                   | T24L         | T32S   | T32          | T32L         | T32XL                      |
|-----------------------------|------------|--|---------------------------|--------------|--|--------------|--------------|----------------------------|
| Drive supply                |            | 230 V (M24S) 380-480 V (T24S)                  | 230 V (M24) 380-480 (T24) | 380-480 V    | 380-480 V                                      | 380-480 V    | 380-480 V    | 380-480 V                  |
| Max payload kg (roping 2:1) |            | 320  | 550                       | 630          | 800  | 1000         | 1275         | 1600                       |
| Static load                 |            | 20 kN  | 20 kN                     | 20 kN        | 26 kN  | 26 kN        | 32 kN        | 41 kN                      |
| Traction sheave Ø mm        |            | 210 240  | 210 240                   | 210 - 240    | 240 - 320                                      | 240 - 320    | 240 - 320    | 320                        |
| Car speed m/s               |            | 0,6 - 2,0                                      | 0,6 - 2,0                 | 1,0 - 2,0    | 1,0 - 2,5                                      | 1,0 - 2,5    | 1,0 - 2,5    | 1,0 - 2,5                  |
| Motor torque Nm             |            | 140  | 200                       | 250          | 330  | 480          | 660          | 850                        |
| Braking torque Nm           |            | 2 x 140  | 2 x 200                   | 2 x 250      | 2 x 330  | 2 x 480      | 2 x 660      | 2 x 900                    |
| DE Bearing                  |            | Locked sealed ball bearing                     |                           |              | Locked sealed ball bearing                     |              |              | Locked sealed roll bearing |
| NDE bearing                 |            | Sealed ball bearing                            |                           |              | Sealed ball bearing                            |              |              | Locked sealed ball bearing |
| Poles                       |            | 24   | 24                        | 24           | 30   | 30           | 30           | 30                         |
| Thermal class               |            | 155° (F)                                       | 155° (F)                  | 155° (F)     | 155° (F)                                       | 155° (F)     | 155° (F)     | 155° (F)                   |
| Degree of protection        |            | IP44   | IP44                      | IP44         | IP44   | IP44         | IP44         | IP44                       |
| Winding protection          |            | 3x PTC 140°C                                   | 3x PTC 140°C              | 3x PTC 140°C | 3x PTC 140°C                                   | 3x PTC 140°C | 3x PTC 140°C | 3x PTC 140°C               |
| Standard and Regulations    |            | 2014/33/EC Directive - UNI EN81-1:1998+A3:2009 |                           |              | 2014/33/EC Directive - UNI EN81-1:1998+A3:2009 |              |              |                            |

FREN ÖZELLİKLERİ BRAKE SPECIFICATIONS ХАРАКТЕРИСТИКА ТОРМОЗА

خصائص الفرمال

| Motor size            | حجم المحرك | M24S/T24S               | M24/T24        | T24L           | T32S                    | T32            | T32L           | T32XL          |
|-----------------------|------------|-------------------------|----------------|----------------|-------------------------|----------------|----------------|----------------|
| Brake Type            |            | EVO-01 FRLF140          | EVO-01 FRLF200 | EVO-01 FRLF250 | EVO-02 FRLF330          | EVO-02 FRLF480 | EVO-03 FRLF660 | EVO-04 FRLF900 |
| Max braking torque Nm |            | 2x140                   | 2x200          | 2x250          | 2x330                   | 2x480          | 2x660          | 2x900          |
| Holding voltage Vdc   |            | 207                     | 207            | 207            | 207                     | 207            | 207            | 207            |
| Holding power W       |            | 2x62                    | 2x62           | 2x62           | 2x85                    | 2x85           | 2x140          | 2x125          |
| Micro switch          |            | 2x3 wires               |                |                | 2X3 wires               |                |                |                |
| Standard              |            | UNI EN81-1:1998+A3:2009 |                |                | UNI EN81-1:1998+A3:2009 |                |                |                |

KODLAYICI ÖZELLİKLERİ ENCODER SPECIFICATIONS ХАРАКТЕРИСТИКА ЭНКОДЕРА

خصائص المشفر

Heidenhain IP64 encoders available in the execution with 5 m outgoing cable without connector:

1. Absolute Sin-Cos 1Vpp (Vsupply5V) with 2048 r/t => ERN487 type\*
2. Absolute EnDat 2.1 13bit (Vsupply 3.6 ... 14V) with 2048 r/t =>ECN413 type

3. Incremental TTL (Vsupply 5V±10%) with 4096 r/t =>ERN421 type
4. Incremental HTL (Vsupply 10V...30V) with 4096 r/t =>ERN431 type

\* As Standard

| TYPE | MAX PAYLOAD<br>MAX PAYLOAD<br>الحمولة العظمى<br>kg | ROPING<br>نظام الربط<br>M <sub>n</sub> | RATED TORQUE<br>RATED TORQUE<br>عزم الدوران<br>Nm | SPEED<br>السرعة<br>m/s | TRACTION SHEAVE Ø<br>TRACTION SHEAVE<br>البكرة<br>mm | MAX ROPES Ø<br>عدد و قطر الحبال<br>mm | POLES<br>الاقطاب | RATED SPEED<br>السرعة المقدرة<br>n<br>min-1 | RATED POWER<br>القدرة<br>kW | CURRENT<br>التيار<br>Amp | FREQUENCY SUPPLY<br>FREQUENCY SUPPLY<br>التردد<br>Hz |
|------|--|--|---|------------------------|--|---------------------------------------|------------------|---|-----------------------------|--------------------------|--|
|------|--|--|---|------------------------|--|---------------------------------------|------------------|---|-----------------------------|--------------------------|--|

**Static load 20 kN** الحمولة الستاتيكية

| M24S / T24S | M24S.240.06 | 240 | 2:1 | 140 | 0.6 | 240     | 6 × 6.5 | 24  | 95  | 1.4  | 7.8  | 19.0 |
|-------------|-------------|-----|-----|-----|-----|---------|---------|-----|-----|------|------|------|
|             | M24S.240.10 | 240 | 2:1 | 140 | 1   | 240     | 6 × 6.5 | 24  | 160 | 2.3  | 10.5 | 32.0 |
|             | M24S.210.06 | 240 | 2:1 | 140 | 0.6 | 210     | 6 × 6.5 | 24  | 110 | 1.6  | 7.8  | 22.0 |
|             | M24S.210.10 | 240 | 2:1 | 140 | 1   | 210     | 6 × 6.5 | 24  | 180 | 2.7  | 10.5 | 36.0 |
|             | M24S.240.06 | 320 | 2:1 | 140 | 0.6 | 240     | 6 × 6.5 | 24  | 95  | 1.4  | 7.8  | 19.0 |
|             | M24S.240.10 | 320 | 2:1 | 140 | 1   | 240     | 6 × 6.5 | 24  | 160 | 2.3  | 10.5 | 32.0 |
|             | T24S.240.10 | 320 | 2:1 | 140 | 1   | 240     | 6 × 6.5 | 24  | 160 | 2.3  | 6.0  | 32.0 |
|             | T24S.240.16 | 320 | 2:1 | 140 | 1.6 | 240     | 6 × 6.5 | 24  | 255 | 3.7  | 8.1  | 51.0 |
|             | T24S.240.20 | 320 | 2:1 | 140 | 2.0 | 240     | 6 × 6.5 | 24  | 320 | 4.6  | 10.5 | 64.0 |
|             | T24S.210.10 | 320 | 2:1 | 140 | 1   | 210     | 6 × 6.5 | 24  | 180 | 2.7  | 6.3  | 36.0 |
| T24S.210.16 | 320         | 2:1 | 140 | 1.6 | 210 | 6 × 6.5 | 24      | 290 | 4.3 | 8.6  | 58.0 |      |
| T24S.210.20 | 320         | 2:1 | 140 | 2.0 | 210 | 6 × 6.5 | 24      | 360 | 5.3 | 11.9 | 72.0 |      |

**Static load 20 kN** الحمولة الستاتيكية

| M24 / T24   | M24.210.06  | 480 | 2:1 | 200 | 0.6 | 210     | 6 × 6.5 | 24  | 110 | 2.3 | 11.1 | 22.0 |
|-------------|-------------|-----|-----|-----|-----|---------|---------|-----|-----|-----|------|------|
|             | M24.240.06  | 480 | 2:1 | 200 | 0.6 | 240     | 6 × 6.5 | 24  | 95  | 2.0 | 10.0 | 19.0 |
|             | M24.210.06  | 550 | 2:1 | 200 | 0.6 | 210     | 6 × 6.5 | 24  | 110 | 2.3 | 10.0 | 22.0 |
|             | T24.240.10  | 480 | 2:1 | 200 | 1   | 240     | 6 × 6.5 | 24  | 160 | 3.3 | 9.1  | 32.0 |
|             | T24.240.16  | 480 | 2:1 | 200 | 1.6 | 240     | 6 × 6.5 | 24  | 255 | 5.3 | 13.1 | 51.0 |
|             | T24.240.20  | 480 | 2:1 | 200 | 2.0 | 240     | 6 × 6.5 | 24  | 320 | 6.7 | 14.4 | 64.0 |
|             | T24.210.10  | 550 | 2:1 | 200 | 1   | 210     | 6 × 6.5 | 24  | 180 | 3.8 | 9.1  | 36.0 |
|             | T24.210.16  | 550 | 2:1 | 200 | 1.6 | 210     | 6 × 6.5 | 24  | 290 | 6.1 | 13.3 | 58.0 |
|             | T24.210.20  | 550 | 2:1 | 200 | 2.0 | 210     | 6 × 6.5 | 24  | 360 | 7.6 | 15.7 | 72.0 |
|             | T24.210.10D | 320 | 1:1 | 200 | 1   | 210     | 6 × 6.5 | 24  | 90  | 1.4 | 5.8  | 18.0 |
| T24.210.16D | 320         | 1:1 | 200 | 1.6 | 210 | 6 × 6.5 | 24      | 145 | 2.3 | 8.3 | 29.0 |      |
| T24.210.20D | 320         | 1:1 | 200 | 2.0 | 210 | 6 × 6.5 | 24      | 180 | 1.6 | 9.1 | 36.0 |      |

**Static load 20 kN** الحمولة الستاتيكية

| T24L | T24L.210.10  | 630 | 2:1 | 250 | 1   | 210 | 6 × 6.5 | 24 | 180 | 4.7 | 11.1 | 36.0 |
|------|--------------|-----|-----|-----|-----|-----|---------|----|-----|-----|------|------|
|      | T24L.210.16  | 630 | 2:1 | 250 | 1.6 | 210 | 6 × 6.5 | 24 | 290 | 7.6 | 15.9 | 58.0 |
|      | T24L.210.20  | 630 | 2:1 | 250 | 2.0 | 210 | 6 × 6.5 | 24 | 360 | 9.5 | 19.9 | 72.0 |
|      | T24L.240.10  | 630 | 2:1 | 250 | 1   | 240 | 6 × 6.5 | 24 | 160 | 4.2 | 11.1 | 32.0 |
|      | T24L.240.16  | 630 | 2:1 | 250 | 1.6 | 240 | 6 × 6.5 | 24 | 255 | 6.7 | 15.9 | 51.0 |
|      | T24L.240.20  | 630 | 2:1 | 250 | 2.0 | 240 | 6 × 6.5 | 24 | 320 | 8.3 | 17.7 | 64.0 |
|      | T24L.240.10D | 320 | 1:1 | 250 | 1   | 240 | 6 × 6.5 | 24 | 80  | 2.1 | 6.5  | 16.0 |
|      | T24L.240.16D | 320 | 1:1 | 250 | 1.6 | 240 | 6 × 6.5 | 24 | 127 | 3.3 | 9.2  | 25.5 |
|      | T24L.240.20D | 320 | 1:1 | 250 | 2.0 | 240 | 6 × 6.5 | 24 | 160 | 4.2 | 11.1 | 32.0 |



| TYPE | MAX PAYLOAD<br>الحمولة العظمى<br>kg | ROPING<br>نظام الربط | RATED TORQUE<br>عزم الدوران<br>Nm | SPEED<br>السرعة<br>m/s | TRACTION SHEAVE Ø<br>البكرة | MAX ROPES Ø<br>عدد وقطر الحبال<br>mm | POLES<br>الاقطاب | RATED SPEED<br>السرعة المقدرة<br>min-1 | RATED POWER<br>القدرة<br>kW | CURRENT<br>التيار<br>Amp | FREQUENCY SUPPLY<br>التردد<br>Hz |
|------|-------------------------------------|----------------------|-----------------------------------|------------------------|-----------------------------|--------------------------------------|------------------|--|-----------------------------|--------------------------|----------------------------------|
|------|-------------------------------------|----------------------|-----------------------------------|------------------------|-----------------------------|--------------------------------------|------------------|--|-----------------------------|--------------------------|----------------------------------|

Static load 26 kN الحمولة الستاتيكية

|      |              |     |     |     |     |     |          |    |     |      |      |      |
|------|--------------|-----|-----|-----|-----|-----|----------|----|-----|------|------|------|
| T32S | T32S.320.10  | 630 | 2:1 | 330 | 1   | 320 | 7 x 8    | 30 | 120 | 4.1  | 11.1 | 30.0 |
|      | T32S.320.16  | 630 | 2:1 | 330 | 1.6 | 320 | 7 x 8    | 30 | 190 | 6.6  | 16.4 | 47.5 |
|      | T32S.320.20  | 630 | 2:1 | 330 | 2.0 | 320 | 7 x 8    | 30 | 240 | 8.3  | 20.7 | 60.0 |
|      | T32S.320.25  | 630 | 2:1 | 330 | 2.5 | 320 | 7 x 8    | 30 | 300 | 10.4 | 23.1 | 75.0 |
|      | T32S.240.10  | 800 | 2:1 | 330 | 1   | 240 | 10 x 6.5 | 30 | 160 | 5.5  | 13.0 | 40.0 |
|      | T32S.240.16  | 800 | 2:1 | 330 | 1.6 | 240 | 10 x 6.5 | 30 | 255 | 8.8  | 20.7 | 63.8 |
|      | T32S.240.20  | 800 | 2:1 | 330 | 2.0 | 240 | 10 x 6.5 | 30 | 320 | 11.0 | 24.6 | 80.0 |
|      | T32S.320.10D | 320 | 1:1 | 330 | 1   | 320 | 7 x 8    | 30 | 60  | 2.1  | 7.0  | 15.0 |
|      | T32S.320.16D | 320 | 1:1 | 330 | 1.6 | 320 | 7 x 8    | 30 | 95  | 3.3  | 8.1  | 23.8 |
|      | T32S.320.20D | 320 | 1:1 | 330 | 2.0 | 320 | 7 x 8    | 30 | 120 | 4.1  | 10.9 | 30.0 |
|      | T32S.320.25D | 320 | 1:1 | 330 | 2.5 | 320 | 7 x 8    | 30 | 150 | 5.2  | 13.0 | 37.5 |
|      | T32S.240.10D | 450 | 1:1 | 330 | 1   | 240 | 10 x 6.5 | 30 | 80  | 2.8  | 7.0  | 20.0 |
|      | T32S.240.16D | 450 | 1:1 | 330 | 1.6 | 240 | 10 x 6.5 | 30 | 127 | 4.4  | 9.8  | 31.8 |
|      | T32S.240.20D | 450 | 1:1 | 330 | 2.0 | 240 | 10 x 6.5 | 30 | 160 | 5.5  | 13.0 | 40.0 |

Static load 26 kN الحمولة الستاتيكية

|     |             |      |     |     |     |     |          |    |     |      |      |      |
|-----|-------------|------|-----|-----|-----|-----|----------|----|-----|------|------|------|
| T32 | T32.320.10  | 800  | 2:1 | 480 | 1   | 320 | 7 x 8    | 30 | 120 | 6.0  | 15.0 | 30.0 |
|     | T32.320.16  | 800  | 2:1 | 480 | 1.6 | 320 | 7 x 8    | 30 | 190 | 9.6  | 22.9 | 47.5 |
|     | T32.320.20  | 800  | 2:1 | 480 | 2.0 | 320 | 7 x 8    | 30 | 240 | 12.1 | 26.7 | 60.0 |
|     | T32.320.25  | 800  | 2:1 | 480 | 2.5 | 320 | 7 x 8    | 30 | 300 | 12.9 | 32.5 | 75.0 |
|     | T32.240.10  | 1000 | 2:1 | 480 | 1   | 240 | 10 x 6.5 | 30 | 160 | 8.0  | 18.1 | 40.0 |
|     | T32.240.16  | 1000 | 2:1 | 480 | 1.6 | 240 | 10 x 6.5 | 30 | 255 | 12.8 | 29.2 | 63.8 |
|     | T32.240.20  | 1000 | 2:1 | 480 | 2.0 | 240 | 10 x 6.5 | 30 | 320 | 16.1 | 34.9 | 80.0 |
|     | T32.320.10D | 480  | 1:1 | 480 | 1   | 320 | 7 x 8    | 30 | 60  | 3.0  | 8.8  | 15.0 |
|     | T32.320.16D | 480  | 1:1 | 480 | 1.6 | 320 | 7 x 8    | 30 | 95  | 4.8  | 13.6 | 23.8 |
|     | T32.320.20D | 480  | 1:1 | 480 | 2.0 | 320 | 7 x 8    | 30 | 120 | 6.0  | 15.0 | 30.0 |
|     | T32.320.25D | 480  | 1:1 | 480 | 2.5 | 320 | 7 x 8    | 30 | 150 | 7.5  | 18.1 | 37.5 |
|     | T32.240.10D | 630  | 1:1 | 480 | 1   | 240 | 10 x 6.5 | 30 | 80  | 4.0  | 10.7 | 20.0 |
|     | T32.240.16D | 630  | 1:1 | 480 | 1.6 | 240 | 10 x 6.5 | 30 | 127 | 6.4  | 15.0 | 31.8 |
|     | T32.240.20D | 630  | 1:1 | 480 | 2.0 | 240 | 10 x 6.5 | 30 | 160 | 8.0  | 18.1 | 40.0 |

Static load 32 kN الحمولة الستاتيكية

|      |              |      |     |     |     |     |          |    |     |      |      |      |
|------|--------------|------|-----|-----|-----|-----|----------|----|-----|------|------|------|
| T32L | T32L.320.10  | 1250 | 2:1 | 660 | 1   | 320 | 7 x 8    | 30 | 120 | 8.3  | 20.5 | 30.0 |
|      | T32L.320.16  | 1250 | 2:1 | 660 | 1.6 | 320 | 7 x 8    | 30 | 190 | 13.2 | 31.4 | 47.5 |
|      | T32L.320.20  | 1250 | 2:1 | 660 | 2.0 | 320 | 7 x 8    | 30 | 240 | 16.6 | 37.8 | 60.0 |
|      | T32L.320.25  | 1250 | 2:1 | 660 | 2.5 | 320 | 7 x 8    | 30 | 300 | 20.7 | 45.7 | 75.0 |
|      | T32L.240.10  | 1275 | 2:1 | 660 | 1   | 240 | 10 x 6.5 | 30 | 160 | 11.0 | 25.2 | 40.0 |
|      | T32L.240.16  | 1275 | 2:1 | 660 | 1.6 | 240 | 10 x 6.5 | 30 | 255 | 17.6 | 37.8 | 63.8 |
|      | T32L.240.20  | 1275 | 2:1 | 660 | 2.0 | 240 | 10 x 6.5 | 30 | 320 | 22.1 | 47.9 | 80.0 |
|      | T32L.320.10D | 600  | 1:1 | 660 | 1   | 320 | 7 x 8    | 30 | 60  | 4.1  | 11.9 | 15.0 |
|      | T32L.320.16D | 600  | 1:1 | 660 | 1.6 | 320 | 7 x 8    | 30 | 95  | 6.6  | 17.3 | 23.8 |
|      | T32L.320.20D | 600  | 1:1 | 660 | 2.0 | 320 | 7 x 8    | 30 | 120 | 8.3  | 20.5 | 30.0 |
|      | T32L.320.25D | 600  | 1:1 | 660 | 2.5 | 320 | 7 x 8    | 30 | 150 | 10.3 | 25.2 | 37.5 |
|      | T32L.240.10D | 800  | 1:1 | 660 | 1   | 240 | 10 x 6.5 | 30 | 80  | 5.5  | 15.8 | 20.0 |
|      | T32L.240.16D | 800  | 1:1 | 660 | 1.6 | 240 | 10 x 6.5 | 30 | 127 | 8.8  | 19.7 | 31.8 |
|      | T32L.240.20D | 800  | 1:1 | 660 | 2.0 | 240 | 10 x 6.5 | 30 | 160 | 11.0 | 25.2 | 40.0 |

Static load 41 kN الحمولة الستاتيكية

|       |               |      |     |     |     |     |        |    |     |      |      |      |
|-------|---------------|------|-----|-----|-----|-----|--------|----|-----|------|------|------|
| T32XL | T32XL.320.10  | 1600 | 2:1 | 850 | 1   | 320 | 10 x 8 | 30 | 120 | 10.7 | 25.1 | 30.0 |
|       | T32XL.320.16  | 1600 | 2:1 | 850 | 1.6 | 320 | 10 x 8 | 30 | 190 | 17.0 | 35.6 | 47.5 |
|       | T32XL.320.20  | 1600 | 2:1 | 850 | 2.0 | 320 | 10 x 8 | 30 | 240 | 21.4 | 45.2 | 60.0 |
|       | T32XL.320.25  | 1600 | 2:1 | 850 | 2.5 | 320 | 10 x 8 | 30 | 300 | 26.7 | 55.0 | 75.0 |
|       | T32XL.320.10D | 800  | 1:1 | 850 | 1   | 320 | 10 x 8 | 30 | 60  | 5.4  | 14.2 | 15.0 |
|       | T32XL.320.16D | 800  | 1:1 | 850 | 1.6 | 320 | 10 x 8 | 30 | 95  | 8.5  | 20.3 | 23.8 |
|       | T32XL.320.20D | 800  | 1:1 | 850 | 2.0 | 320 | 10 x 8 | 30 | 120 | 10.7 | 25.1 | 30.0 |
|       | T32XL.320.25D | 800  | 1:1 | 850 | 2.5 | 320 | 10 x 8 | 30 | 150 | 13.4 | 30.1 | 37.5 |



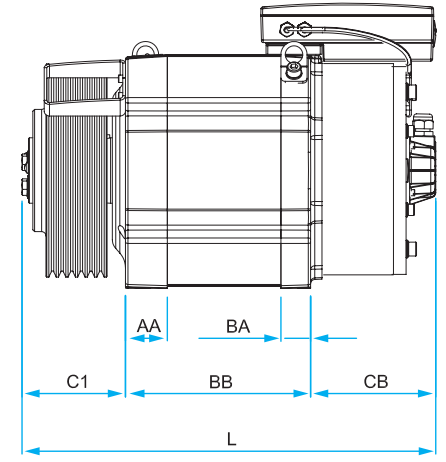
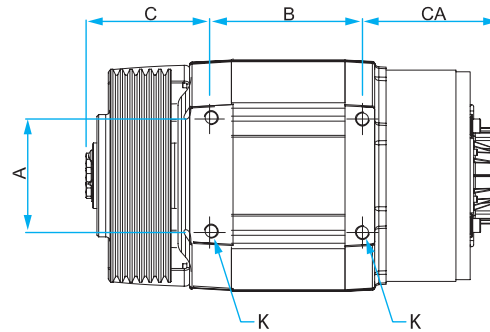
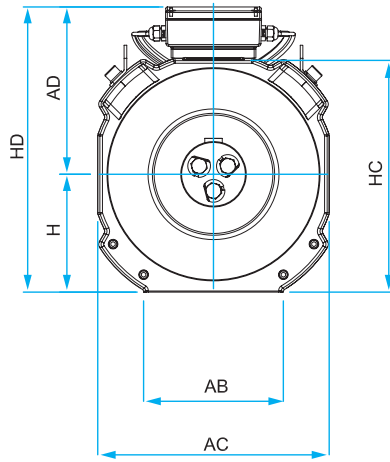

| TYPE             | A   | B   | K   | C   | C1  | CA  | CB  | BB  | AA | BA | L   | AC  | AB  | HD  | H   | AD  | HC  | WEIGHT<br>kg |
|------------------|-----|-----|-----|-----|-----|-----|-----|-----|----|----|-----|-----|-----|-----|-----|-----|-----|--------------|
| M24S/T24S.210.XX | 130 | 175 | M16 | 141 | 118 | 157 | 143 | 212 | 48 | 34 | 474 | 265 | 160 | 327 | 135 | 192 | 268 | 127          |
| M24S/T24S.240.XX | 130 | 175 | M16 | 141 | 118 | 157 | 143 | 212 | 48 | 34 | 474 | 265 | 160 | 327 | 135 | 192 | 268 | 132          |
| M24/T24.210.XX   | 130 | 215 | M16 | 141 | 118 | 157 | 143 | 252 | 48 | 34 | 514 | 265 | 160 | 327 | 135 | 192 | 268 | 135          |
| M24/T24.240.XX   | 130 | 215 | M16 | 141 | 118 | 157 | 143 | 252 | 48 | 34 | 514 | 265 | 160 | 327 | 135 | 192 | 268 | 140          |
| T24.210.XX.D     | 130 | 215 | M16 | 141 | 118 | 157 | 143 | 252 | 48 | 34 | 514 | 265 | 160 | 327 | 135 | 192 | 268 | 140          |
| T24L.210.XX      | 130 | 255 | M16 | 158 | 135 | 157 | 143 | 292 | 48 | 34 | 570 | 265 | 160 | 327 | 135 | 192 | 268 | 153          |
| T24L.240.XX      | 130 | 255 | M16 | 158 | 135 | 157 | 143 | 292 | 48 | 34 | 570 | 265 | 160 | 327 | 135 | 192 | 268 | 158          |
| T24L.210.XX.D    | 130 | 255 | M16 | 158 | 135 | 157 | 143 | 292 | 48 | 34 | 570 | 265 | 160 | 327 | 135 | 192 | 268 | 153          |
| T24L.240.XX.D    | 130 | 255 | M16 | 158 | 135 | 157 | 143 | 292 | 48 | 34 | 570 | 265 | 160 | 327 | 135 | 192 | 268 | 158          |
| T32S.240.XX      | 170 | 175 | M20 | 175 | 157 | 155 | 135 | 213 | 58 | 60 | 505 | 348 | 208 | 396 | 175 | 221 | 350 | 189          |
| T32S.320.XX      | 170 | 175 | M20 | 159 | 140 | 155 | 135 | 213 | 58 | 60 | 488 | 348 | 208 | 396 | 175 | 221 | 350 | 184          |
| T32S.240.XX.D    | 170 | 175 | M20 | 175 | 157 | 155 | 135 | 213 | 58 | 60 | 505 | 348 | 208 | 396 | 175 | 221 | 350 | 189          |
| T32S.320.XX.D    | 170 | 175 | M20 | 159 | 140 | 155 | 135 | 213 | 58 | 60 | 488 | 348 | 208 | 396 | 175 | 221 | 350 | 184          |
| T32.240.XX       | 170 | 215 | M20 | 175 | 157 | 155 | 135 | 253 | 58 | 60 | 545 | 348 | 208 | 396 | 175 | 221 | 350 | 215          |
| T32.320.XX       | 170 | 215 | M20 | 159 | 140 | 155 | 135 | 253 | 58 | 60 | 528 | 348 | 208 | 396 | 175 | 221 | 350 | 210          |
| T32.240.XX.D     | 170 | 215 | M20 | 175 | 157 | 155 | 135 | 253 | 58 | 60 | 545 | 348 | 208 | 396 | 175 | 221 | 350 | 215          |
| T32.320.XX.D     | 170 | 215 | M20 | 159 | 140 | 155 | 135 | 253 | 58 | 60 | 528 | 348 | 208 | 396 | 175 | 221 | 350 | 210          |
| T32L.240.XX      | 170 | 260 | M20 | 175 | 157 | 162 | 142 | 298 | 58 | 60 | 597 | 348 | 208 | 396 | 175 | 221 | 350 | 264          |
| T32L.320.XX      | 170 | 260 | M20 | 159 | 140 | 162 | 142 | 298 | 58 | 60 | 580 | 348 | 208 | 396 | 175 | 221 | 350 | 259          |
| T32L.240.XX.D    | 170 | 260 | M20 | 175 | 157 | 162 | 142 | 298 | 58 | 60 | 597 | 348 | 208 | 396 | 175 | 221 | 350 | 264          |
| T32L.320.XX.D    | 170 | 260 | M20 | 159 | 140 | 162 | 142 | 298 | 58 | 60 | 580 | 348 | 208 | 396 | 175 | 221 | 350 | 259          |
| T32XL.320.XX     | 170 | 326 | M20 | 196 | 172 | 203 | 173 | 380 | 77 | 73 | 725 | 352 | 209 | 425 | 180 | 245 | 355 | 380          |
| T32XL.320.XX.D   | 170 | 326 | M20 | 196 | 172 | 203 | 173 | 380 | 77 | 73 | 725 | 352 | 209 | 425 | 180 | 245 | 355 | 380          |



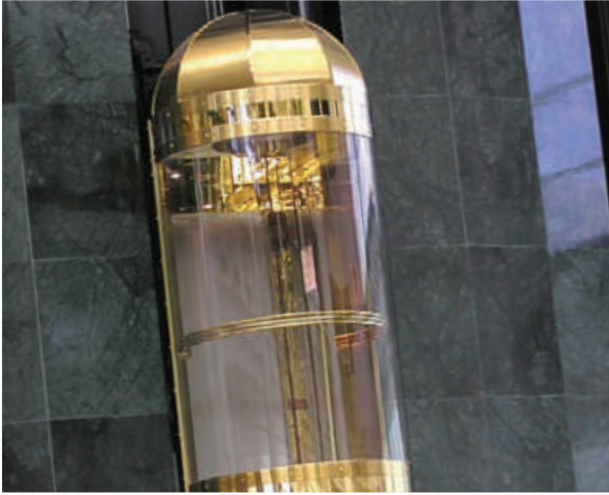

|  |   |   |
|--|---|---|
| Drive supply التغذية   | <input type="checkbox"/> Single-phase 230V<br>فاز واحد 230 v  | <input type="checkbox"/> Three-phase 400V<br>ثلاثة فازات 400 v  |
| Max payload الحمولة العظمى   | <input type="checkbox"/> 240 kg<br><input type="checkbox"/> 320 kg<br><input type="checkbox"/> 450 kg<br><input type="checkbox"/> 480 kg<br><input type="checkbox"/> 600 kg<br><input type="checkbox"/> 630 kg  | <input type="checkbox"/> 800 kg<br><input type="checkbox"/> 1000 kg<br><input type="checkbox"/> 1250 kg<br><input type="checkbox"/> 1275 kg<br><input type="checkbox"/> 1600 KG<br><input type="checkbox"/> other ____ kg |
| Traction sheave Ø external قطر البكرة الخارجية                             | <input type="checkbox"/> 210 mm<br><input type="checkbox"/> 240 mm  | <input type="checkbox"/> 320 mm<br><input type="checkbox"/> other ____mm  |
| Ropes no. Ø عدد الحبال   | <input type="checkbox"/> 4<br><input type="checkbox"/> 5<br><input type="checkbox"/> 6<br><input type="checkbox"/> other ____   | <input type="checkbox"/> 7<br><input type="checkbox"/> 8<br><input type="checkbox"/> 10   |
| Ropes Ø قطر الحبال   | <input type="checkbox"/> 6.5 mm<br><input type="checkbox"/> 8 mm  | <input type="checkbox"/> other ____mm   |
| Traction sheave groove profile مواصفات خنادق البكرة الخارجية               | <input type="checkbox"/> $V \gamma = 50^\circ$<br><input type="checkbox"/> $V \gamma = \_\_\circ$<br><input type="checkbox"/> semi-circular with notch $\gamma = 30^\circ \beta = 100^\circ$<br><input type="checkbox"/> semi-circular with notch $\gamma = \_\_\circ \beta = \_\_\circ$<br><input type="checkbox"/> other ____ |   |
| Roping الربط   | <input type="checkbox"/> 2:1  | <input type="checkbox"/> 1:1  |
| Plant speed سرعة الكابينة  | <input type="checkbox"/> 0.5 m/s<br><input type="checkbox"/> 0.6 m/s<br><input type="checkbox"/> 1.0 m/s<br><input type="checkbox"/> other ____m/s  | <input type="checkbox"/> 1.6 m/s<br><input type="checkbox"/> 2.0 m/s<br><input type="checkbox"/> 2.5 m/s  |
| Encoder type نوع الكودر<br>(as standard: absolute sin-cos 1Vpp 2048p/t 5V) | <input type="checkbox"/> incremental TTL 4096p/t 5V<br><input type="checkbox"/> incremental HTL 4096p/t 10...30V<br><input type="checkbox"/> absolute EnDat 2.1 13bit 2048p/t 3.6...14V   |   |
| Requested options خيارات إضافية  | <input type="checkbox"/> brake hand release (check max. NE distance available ____ mm)<br><input type="checkbox"/> other ____   |   |

Asansörler için dişlisiz makinenin tam tanımı için gerekli veriler, müşteri tarafından doldurulmalıdır.

Needed data for the complete definition of the gearless machine for elevators, to be filled in by customer.

Данные, необходимые для точного описания безредукторной машины для лифтов, должны быть заполнены заказчиком.

في الأعلى المعلومات اللازمة من أجل طلب محرك جيرلس، يتم تعبئتها من قبل العميل.



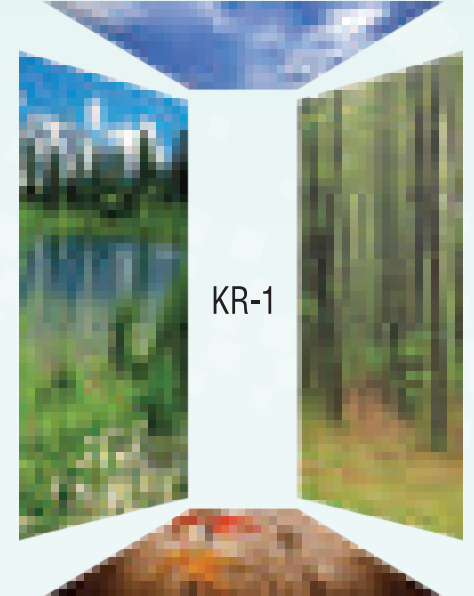
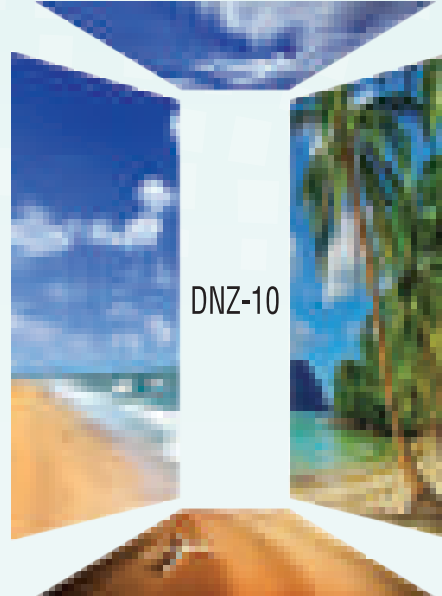

*Not: Daha fazlası için satış bölümümüzle irtibata geçiniz.*

Примечание: Для получения дополнительной информации свяжитесь с нашим отделом продаж.

## KBN 15 Görsel Seçenekleri

KBN 15 Images Options

Выбор 15 Изображий для Кабин

خيارات الصور الداخلية للكبائن

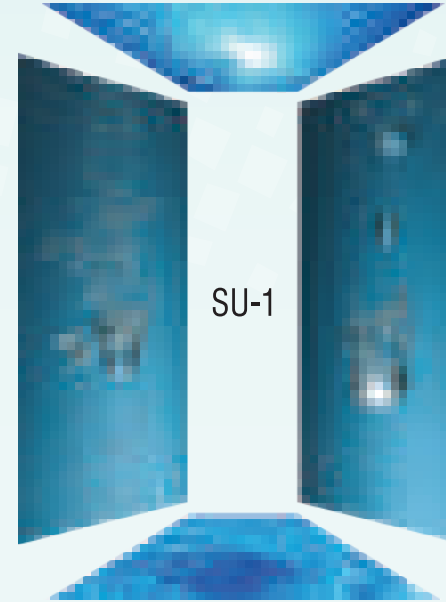

*Note: For full image catalogue please call our sales department.*

ملاحظة، للحصول على تشكيلة أوسع من الرسومات يرجى التواصل معنا





Çetali Alüminyum

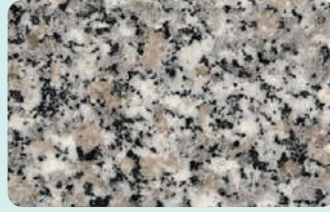

Granit Rosa Beta



Granit Rosa Porino

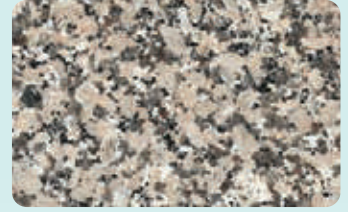

Granit Rosa Minho



Granit Star Galaxy



Siyah Granit

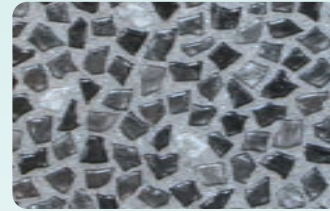

Dere Taşı / River Stones -01



Dere Taşı / River Stones -02

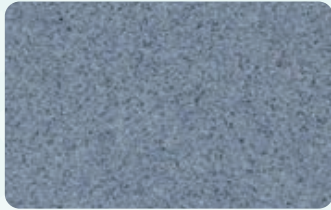

PVC-001

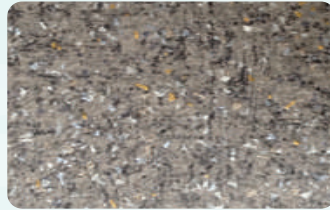

PVC - 002



PVC - 003



PVC - 004

Lamine Camlar / Laminated Glasses / Ламинированные Стекла / بعض خيارات الجدران الزجاجية



Kırmızı / Red

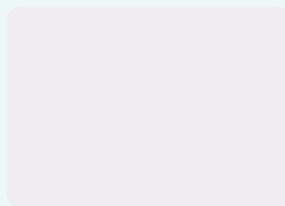

Bej / Beige



Mavi / Blue

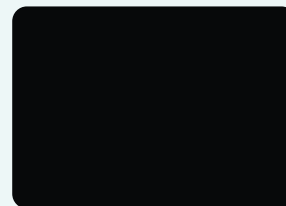

Siyah / Black



Turkuaz / Turquoise

## Tavan Seçenekleri

Ceiling Options

Выбор Потолков

خيارات سقف وأرضيات الكابائن



TVN 001



TVN 002



TVN 003



TVN 004



TVN 005



TVN 006



TVN 007



TVN 008



TVN 009



TVN 010



TVN 012



TVN 013



TVN 014



TVN 015



TVN 016

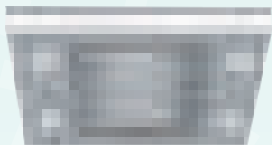

TVN 018



TVN 019



TVN 020



TVN 021



TVN 023



TVN 024

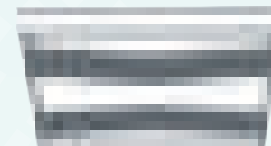

TVN 025

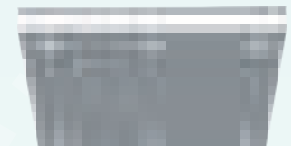

TVN 026



TVN 027

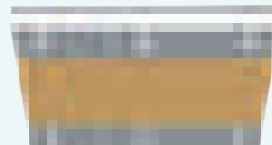

TVN 028





Mirror Ti-Gold



Mirror



Mirror Ti-Rose



Mirror Ti-Black



Mirror Ti-Gold CX-86



Hairline Ti-Gold



Hairline



Hairline Ti-Rose



Hairline Ti-Black



Mirror CX-86

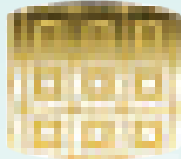

Hairline Ti-Gold CX-41



Hairline Ti-Gold CX-37



Hairline Ti-Gold CX-08



Mirror Ti-Gold CX-06



Mirror Ti-Rose CX-16



Mirror Ti-Gold CX-26

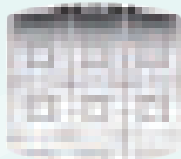

Mirror CX-41



Mirror CX-37



Mirror CX-03



Mirror CX-34



Mirror Ti-Gold CX-20



Mirror CX-26



Mirror Ti-Gold CX-51



Mirror Ti-Gold CX-82



Mirror Ti-Bronze CX-24



Mirror Ti-Gold CX-53



Mirror Ti-Gold CX-59



Mirror Ti-Bronze CX-99



Mirror Ti-Gold CX-58



Mirror Ti-Gold CX-51



Mirror CX-82



Mirror CX-24



Mirror CX-53



Mirror CX-59



Hairline CX-99



Mirror CX-58

## Paslanmaz ve Laminat Seçenekleri

Stainless and Laminate Options

Варианты из Нержавеющей Стали и Ламината

خيارات الزخرفة



Akaju



Akçaağaç



Altın Meşe



Bambu

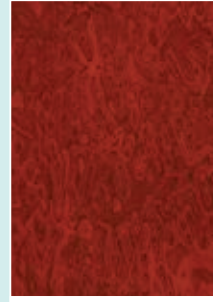

Bordo Kuşgözü



Elma



İpek Zeytin



İtalyan Cevizi



Kırmızı



Doğal Kiraz



Zeytin



Koyu Kiraz

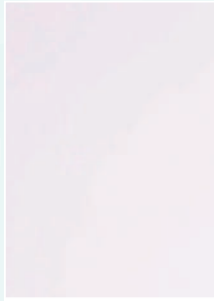

Krem



Meşe



Mürdüm

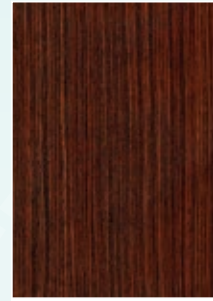

Pelesenk

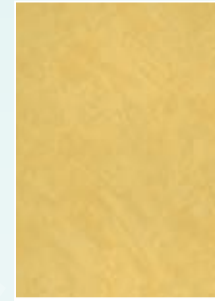

Samsara



Tilya



Wenge



Yaban Cevizi



Yeni Kayın



Zebrano



# Sertifikalarımız

Our Certificates

Сертификаты

شهاداتنا

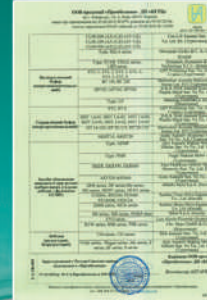
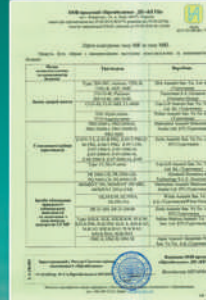
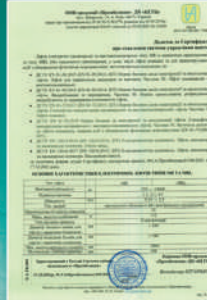
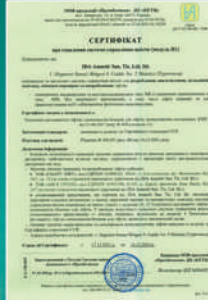



المصاعد  
lift  
asansör

“carries life”

“yaşam taşır”

تحمل الحياة

“несет жизнь”







ida | lift  
asansör

ida | lift  
asansör  
*MRL*

Overmac



# ida lift asansör



Turkey

FABRİKA / FACTORY / ФАБРИКА / المصنع

+90 422 237 63 20

+90 422 237 63 24

info@idaasansor.com.tr

1. Organize Sanayi Bölgesi 9. Cad.  
No: 5 - MALATYA / TURKEY

TEŞHİR / SHOWROOM / ВЪСТАВОЧНЫЙ ЗАЛ / صالة عرض

+90 216 364 11 41

Şerifali Mahallesi Miras Sokak No:1-3A,  
34775 Ümraniye / İSTANBUL / TURKEY

[www.idaasansor.com.tr](http://www.idaasansor.com.tr)



Turkey  
Discover the potential